

# EUROLASER<sup>NEW</sup>

by AIKIE



## Katalog 2015 | 2016



## Perfect. Economic. EUROLASER<sup>NEW</sup>

Hier finden Sie das perfekte Kreissägeblatt für Ihre Anwendung.



### Hochwertiges Stammblatt

Aufgrund des hochwertigen Stammblatts und der zusätzlich eingebrachten Dehnungsschlitze erhält das Sägeblatt eine extreme Laufruhe und Stabilität

### Zahngeometrie

Zahngeometrie und Hartmetall sind speziell auf die Anwendung abgestimmt

### Laserornamente

Laserornamente im Stammblatt sorgen für einen schwingungsarmen Lauf und eine deutliche Geräuschreduzierung

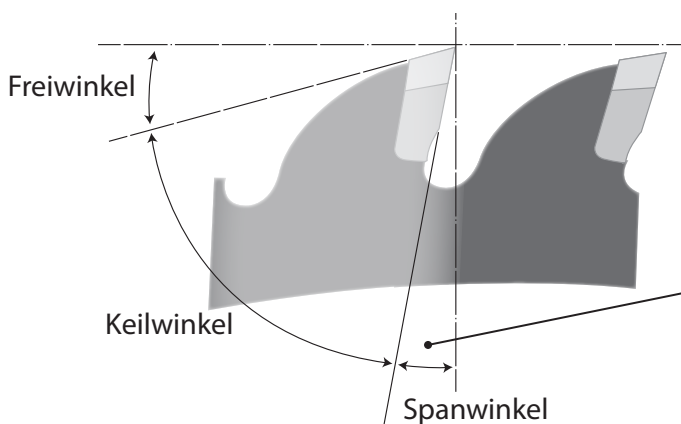

### Spanwinkel

Für schnellen und leichten Schnitt:

- Stark positiv bei weicheren Materialien
- Weniger positiv bei harten Materialien
- Negativ bei Kappschnitten

## Zahnformen



### Wechselzahn Geometrie

Die Zähne sind hier im Wechsel nach links und rechts abgeschragt und schneiden somit abwechselnd. Die Wechselzahn-Geometrie ist für alle Holzwerkstoffe universell einsetzbar.



### Trapez-Flachzahn Geometrie

Trapezzahn und Flachzahn sind im Wechsel angeordnet. Diese Geometrie wird zum Sägen von Aluminium, harten Kunststoffen und hartbeschichteten Werkstoffen eingesetzt.



### Trapezzahn Geometrie

Diese Geometrie wird zum Sägen beidseitig beschichteter Plattenwerkstoffe, Kunststoffe und Massivholz verwendet.

# Technische Informationen

## Kreissägeblätter

### Schnittgeschwindigkeits-Richtwerte (m/s)

für HW-Kreissägeblätter in Abhängigkeit zum Werkstoff

Werkstoff	Bezeichnung	m/s
Weichholz	Kiefer	60-100
Hartholz	Buche	60-100
Lagenholz	Multiplex	50-80
Verbundplatte	ST/STAE	50-90
Hartfaserplatten	HDF	50-80
Mitteldichte FP	MDF	60-80
Holzspanplatten	FPY	60-80
Schichtstoffplatten	KF	60-80
Gipsplatten	Karton	40-65
Bauplatten	zementgebunden	40-60
Hartkunststoffe	Duroplast	15-50
Weichkunststoffe	Plastomere	30-70
Hartgewebepplatten	(-paper)	50-70
Steinwollplatten	Rockwool	2-8

### Drehzahl n (1/min)

D mm	1.500	2.000	2.500	2.850	3.000	4.000	4.500	5.000	5.600	6.000	8.000	9.000	10.000	12.000	18.000
50	4	5	7	7,5	8	11	12	14	14,5	16	22	24	28	32	48
60	5	6	8	9	10	13	14	16	17,5	20	26	28	32	40	56
70	5,5	7	9	10,5	11	15	16,5	18	20,5	22	30	33	36	44	66
80	6,5	8,5	10,5	12	13	17	19	21	23,5	26	34	38	42	52	76
90	7	9,5	12	13,5	14	19	21	24	26,5	28	38	42	48	56	84
100	8	10,5	13	15	16	21	24	26	29	32	42	48	52	54	96
120	9,5	13	16	18	19	26	28	32	35	38	52	56	64	76	112
125	10	13,5	16,5	18,5	19,5	27	29	33	36,5	39	54	59	66	78	118
140	11	15	18	21	22	30	33	36	41	44	60	66	72	88	132
150	12	15,5	19,5	22,5	23,5	31,5	33,5	39	44	47	63	70,5	78,5	94,5	141,5
160	13	17	21	24	26	34	38	42	47	52	67	76	84	104	152
180	14	19	24	27	28	38	42,5	48	53	56	76	85	96	118	170
200	16	21	26	30	32	42	47	52	58,5	64	84	94	104	128	188
225	18	24	30	33,5	36	48	58	60	66	72	96	106	120	144	212
250	20	26	33	37	40	52	59	66	73,5	80	104	118	132	160	236
300	24	31,5	40	45	48	63	71	80	88	96	126	142	160	192	284
350	28	36,5	47	52	56	73	83	94	105	112	146	166	188	224	332
400	32	42	54	60	64	84	94	108	117	128	168	188	216	256	376
450	35,5	47	59	67,5	70,5	94,5	106	118	132	141,6	188	211	236	283	424
500	40	53	67	74,5	80	106	118	134	146,5	160	212	236	268	320	472







Die auf den Werkzeugen angegebenen höchstzulässigen Drehzahlen n bis ... dürfen in keinem Falle überschritten werden. Sie kennzeichnen die Sicherheitsgrenze; sie sind nicht identisch mit den Drehzahlen, die optimale Wirtschaftlichkeit erbringen.



















- Mineralfaserplatten
- NE-Metalle
- Holzwerkstoffe und Kunststoffe
- - - Naturholz (hart)
- // // // Naturholz (weich)
- Sicherheitsgrenze

Schnittgeschwindigkeit





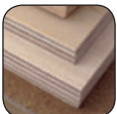

$$VS = \frac{D \cdot \pi \cdot n}{60 \cdot 1000} \text{ (m/s)}$$

















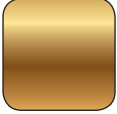

Kreissägeblätter nach Artikelnummer mit Anwendung

Type	Maschine	Ausführung
 <p><b>Universal- kreissägeblätter</b> 10, 12, 14, 15</p>	Tisch- und Formatkreissäge	Wechselzahn mit und ohne Spandickenbegrenzer
 <p><b>Holzwerk- stoffsägeblätter</b> 21, 25, 27</p>	Tisch- und Formatkreissäge	Flach-Trapezzahn Hohl-Dach-Flach (positiv und negativ)
 <p><b>Wechselzahn extrem 35°</b> 19</p>	Tisch- und Formatkreissäge	Wechselzahn 35° mit negativem Spanwinkel
 <p><b>Handkreissäge- blätter</b> 47</p>	Handkreissäge, Tischkreissäge	Wechselzahn Flach-Trapezzahn In vielen Spezialausführ- ungen für Festool, Mafell, Makita, DeWalt, Bosch, etc.
 <p><b>Nutfräser für Lamellen</b> 47</p>	Handmaschine	Wechsel-Wechsel-Flachzahn
 <p><b>Kappkreissäge- blätter</b> 18</p>	Kappkreissäge	Wechselzahn mit negativem Spanwinkel

Anwendung	Werkstoff			
Längsschnitt, Querschnitt				
	Massivholz weich bis hart	Holzwerkstoff		
Formatbearbeitung. Längsschnitt, Querschnitt				
	Holzwerkstoff roh	Holzwerkstoff beschichtet	Duroplast	Thermoplast
Formatbearbeitung in Holz- werkstoff, Querschnitte in Massivholz				
	Holzwerkstoff roh	Holzwerkstoff beschichtet	Massivholz	
Längsschnitt, Querschnitt				
	Massivholz	Holzwerkstoff roh	Holzwerkstoff beschichtet	Kunststoff
Zum Einnuten von Lamellen Verbindungsplättchen				
	Holzwerkstoff roh	Holzwerkstoff beschichtet	Massivholz	
Querschnitt				
	Massivholz	Holzwerkstoff roh	Thermoplast	Duroplast-Profil

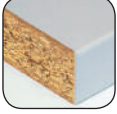
Kreissägeblätter nach Artikelnummer mit Anwendung

Type	Maschine	Ausführung
 <p><b>Aluminiumkreissägeblätter</b> 40</p>	Tisch- und Formatkreissäge	Flach-Trapezzahn
 <p><b>Aluminiumkreissägeblätter</b> 42</p>	Handkreissäge, Tisch- und Formatkreissäge, Kappkreissäge	Flach-Trapezzahn mit negativem Spanwinkel
 <p><b>Sandwich-Kreissägeblätter</b> 54</p>	Baukreissäge, Handkreissäge, Kappkreissäge	Flach-Trapezzahn mit negativem Spanwinkel und Sonderhartmetall
 <p><b>Dry-Cut-Kreissägeblätter</b> 56</p>	Dry-Cutter für Trockenschnitte ohne Schmierung	Wechselzahn mit Flachfase
 <p><b>Zuschnitt- und Baukreissägeblätter</b> 49, 50</p>	Wippsäge, Brennholzsäge, Baukreissäge	Wechselzahn, Trapez Zahn Zähes Hartmetall und stabiler Zahnrücken
 <p><b>Diamant-Kreissägeblätter (DP)</b> DH18</p>	Handkreissäge, Tisch- und Formatkreissäge, Kappkreissäge	Diamant-Sägeblätter für extreme Standzeit. Optimierte Flachzahn-Geo- metrie mit negativem Span- winkel und Spandickenbe- grencer. Dünne Schnittbreite
 <p><b>CV-Kreissägeblätter</b> CV51, CV52</p>	Wippsäge, Brennholzsäge, Baukreissäge, Tischkreissäge	Chrom-Vanadium Kreissägeblätter KV-A Wolfszahn, NV-B Spitzzahn

Anwendung	Werkstoff			
Bearbeitung von Aluminium in Profil, Platte, Stange				
	Aluminium	Kupferlegierung (z.B. Messing)	Kunststoff	
Bearbeitung von NE-Metallen, Kunststoff, universeller Einsatz				Thermo-fassadenelement, Verbundwerkstoff
	Aluminium	Holzwerkstoff	Kunststoff	
Bearbeitung von Sandwichmaterialien				
	Sandwichelement, blechbewehrt ohne Steinwolle			
Kappschnitt				Profilblech Kabelkanal usw.
	Baustahl	Kupfer	Aluminium	
Universeller Einsatz auf Bau- und Wippsägen				Schalungsmaterial
	Massivholz	Heraklithplatte	Holzwerkstoff roh	
Niedrige Zähnezahl für groben Zuschnitt Höhere Zähnezahl für bessere Schnittergebnisse				Zementfaserplatte, werkzeugverschleißende Materialien
	Holzwerkstoff roh	Holzwerkstoff beschichtet	Kunststoff	Massivholz
Längsschnitt, Querschnitt				
	Massivholz	Holzwerkstoff roh		

# Kreissägeblätter

Perfect. Economic. **EUROLASER**<sup>NEW</sup>



## HOCHWERTIGER UND WIDERSTANDSFÄHIGER STAHL

Wir verwenden ausschließlich hochwertigen Stahl für die Fertigung unserer Kreissägeblätter. Damit gewährleisten wir eine hervorragende Lebensdauer.

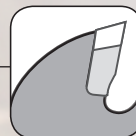

## OPTIMAL AUSGELEGTE ZAHNGEOMETRIEN

Unsere Kreissägeblätter sind mit optimalen und materialschonenden Zahngeometrien für das jeweilige Anwendungsgebiet ausgestattet - für ein Maximum an Schnittqualität über lange Standwege.



## DURCH NACHSCHÄRFUNG MEHRFACH VERWENDBAR

Alle EUROLASER NEW-Hartmetall-Kreissägeblätter sind mehrfach nachschärfbar und somit für eine lange und wirtschaftliche Nutzung ausgelegt.



## SPEZIELLE UND UNIVERSELLE ANWENDUNGSFELDER

Die Kreissägeblätter gibt es je nach Anwendungsbereich und Werkstoff in verschiedenen Ausführungen. Ob als Universal- oder Spezialkreissägeblatt: Mit diesem Produkt erhalten Sie immer zuverlässiges Präzisionswerkzeug.



## GERMAN TECHNOLOGY

Seit 1960 entstehen bei A|K|E qualitativ hochwertige Kreissägeblätter. Dieses gewachsene Know-How von über 50 Jahren steckt nachweislich in jedem Kreissägeblatt.

Perfect. Economic.  
Best Price & German Technology.





## Kreissägeblätter

### Lames de scie carbure

Universalkreissägeblatt Lames universelles.....	10 - 11
Holzwerkstoffkreissägeblatt Lames pour scie à panneaux.....	12 - 14
Kreissägeblatt Wechselzahn extrem, 35° Lames alternées 35° .....	14
Handkreissägeblatt Lames pour machines portatives .....	15 - 20
Nutfräser für Lamellen Fraises à rainer .....	20
Spezialabmessungen für Mafell® und Festool® Lames pour machines portatives Mafell® et Festool® .....	21 - 22
Diamant-Trennscheiben Disques à tronçonner diamantés .....	23
Kappkreissägeblatt Lames pour bois et profilés PVC .....	24
Zuschnittkreissägeblatt Lames pour machines stationnaires .....	25
Baukreissägeblatt Lames de chantier, pour bois massif .....	26
Aluminiumkreissägeblatt Lames pour ALU et PVC.....	27 - 29
Sandwichkreissägeblatt Lames pour panneaux sandwich .....	30
Dry-Cut-Kreissägeblatt Lames Dry-Cut .....	31
Diamant-Kreissägeblatt (DP) Lames de scie Diamant (DP) .....	32 - 33
CV-Kreissägeblatt Lames chrome-vanadium.....	34 - 35
HSS Sägeblätter Fraises scie HSS pour l'acier.....	36 - 37
Reduzierringe Bagues de réduction .....	38

## Universalkreissägeblatt, spandickenbegrenzt

Lames pour bois massif, avec limiteurs de passe



ANWENDUNG	Längsschnitt, Querschnitt
WERKSTOFF	Massivholz weich bis hart, Holzwerkstoff
MASCHINE	Tisch- und Formatkreissäge
AUSFÜHRUNG	Spandickenbegrenzt (SDB)
ZAHN	Wechselzahn (W), HW
UTILISATION	Coupe en long et en travers
MATERIAU	Bois massif tendre, dur, bois lamellé, Thermoplast
MACHINE	Scie à format
EXECUTION	Avec limiteurs de prise de passe (SDB), et sans SDB
DENTURE	Alternée (W), HW

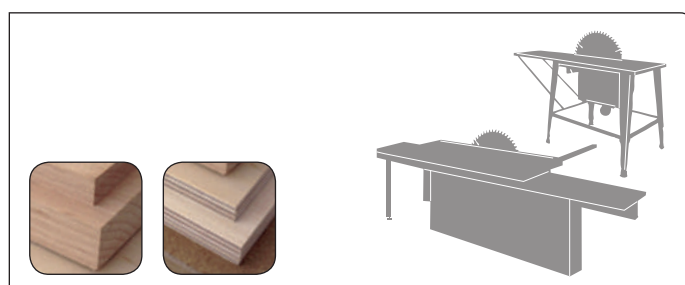
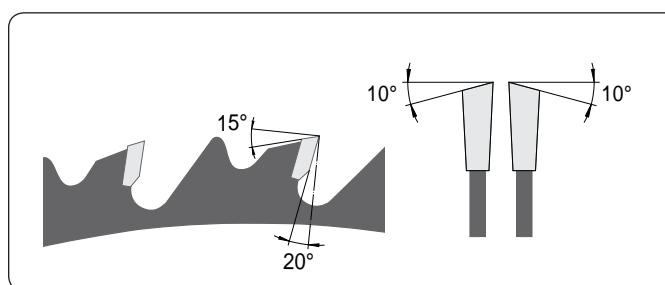

D mm	B mm	b mm	d mm	NL/TK mm TE	Z	Zahnform Denture	Bestellnummer Références	Preis Prix
250	3,20	2,20	30	2/7/42 + 2/9/46,5 + 2/10/60	24	W, SDB	10.250.30.24	63,00 CHF
300	3,20	2,20	30	2/7/42 + 2/9/46,5 + 2/10/60	28	W, SDB	10.300.30.28	78,00 CHF
NEU 315	3,20	2,20	30	2/7/42 + 2/9/46,5 + 2/10/60	28	W, SDB	10.315.30.28	83,00 CHF
350	3,50	2,50	30	2/7/42 + 2/9/46,5 + 2/10/60	32	W, SDB	10.350.30.32	88,00 CHF
400	3,50	2,50	30	2/7/42 + 2/9/46,5 + 2/10/60	36	W, SDB	10.400.30.36	109,00 CHF
450	4,40	2,80	30	2/7/42 + 2/9/46,5 + 2/10/60	40	W, SDB	10.450.30.40	138,00 CHF
500	4,40	2,80	30	2/7/42 + 2/9/46,5 + 2/10/60	44	W, SDB	10.500.30.44	165,00 CHF

# Universalkreissägeblatt

Lames universelles



ANWENDUNG	Längsschnitt, Querschnitt
WERKSTOFF	Massivholz weich bis hart, Holzwerkstoff
MASCHINE	Tisch- und Formatkreissäge
ZAHN	Wechselzahn (W), HW
UTILISATION	Coupe en long et en travers
MATERIAU	Bois massif tendre, dur, bois lamellé, Thermoplast
MACHINE	Scie à format
DENTURE	Alternée (W), HW

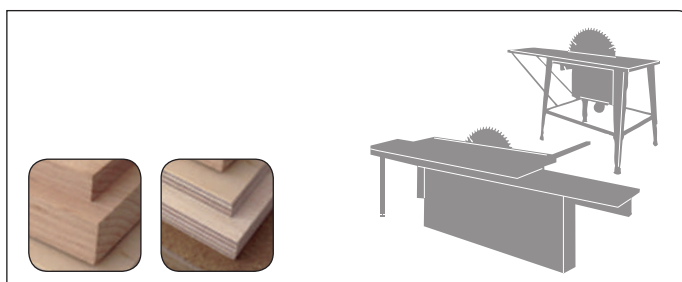
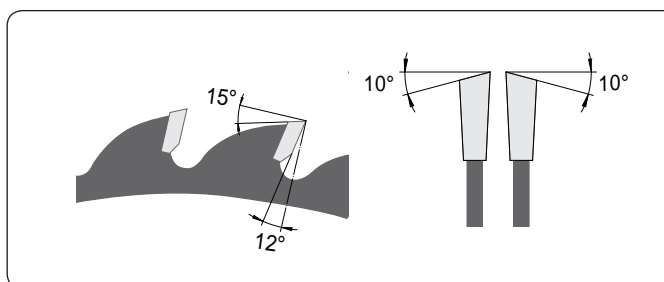

## Niedrige Zähnezahl [12] Lames à faible nombre de dents

D mm	B mm	b mm	d mm	NL/TK mm TE	Z	Zahnform Denture	Bestellnummer Références	Preis Prix
250	3,20	2,20	30	2/7/42 + 2/9/46,5 + 2/10/60	40	W	12.250.30.40	77,00 CHF
300	3,20	2,20	30	2/7/42 + 2/9/46,5 + 2/10/60	36	W	12.300.30.36	83,00 CHF
300	3,20	2,20	30	2/7/42 + 2/9/46,5 + 2/10/60	48	W	12.300.30.48	96,00 CHF
NEU 315	3,20	2,20	30	2/7/42 + 2/9/46,5 + 2/10/60	48	W	12.315.30.48	103,00 CHF
NEU 350	3,50	2,50	30	2/7/42 + 2/9/46,5 + 2/10/60	42	W	12.350.30.42	114,00 CHF

## Mittlere Zähnezahl [14] Lames avec nombre de dents moyennement élevé

D mm	B mm	b mm	d mm	NL/TK mm TE	Z	Zahnform Denture	Bestellnummer Références	Preis Prix
250	3,20	2,20	30	2/7/42 + 2/9/46,5 + 2/10/60	48	W	14.250.30.48	86,00 CHF
250	3,20	2,20	30	2/7/42 + 2/9/46,5 + 2/10/60	60	W	14.250.30.60	99,00 CHF
300	3,20	2,20	30	2/7/42 + 2/9/46,5 + 2/10/60	60	W	14.300.30.60	110,00 CHF
300	3,20	2,20	30	2/7/42 + 2/9/46,5 + 2/10/60	72	W	14.300.30.72	127,00 CHF
NEU 315	3,20	2,20	30	2/7/42 + 2/9/46,5 + 2/10/60	60	W	14.315.30.60	118,00 CHF
NEU 315	3,20	2,20	30	2/7/42 + 2/9/46,5 + 2/10/60	72	W	14.315.30.72	136,00 CHF
350	3,50	2,50	30	2/7/42 + 2/9/46,5 + 2/10/60	54	W	14.350.30.54	126,00 CHF
350	3,50	2,50	30	2/7/42 + 2/9/46,5 + 2/10/60	72	W	14.350.30.72	143,00 CHF
350	3,50	2,50	30	2/7/42 + 2/9/46,5 + 2/10/60	84	W	14.350.30.84	155,00 CHF

## Hohe Zähnezahl [15] Lames à grand nombre de dents

D mm	B mm	b mm	d mm	NL/TK mm TE	Z	Zahnform Denture	Bestellnummer Références	Preis Prix
250	3,20	2,20	30	2/7/42 + 2/9/46,5 + 2/10/60	80	W	15.250.30.80	119,00 CHF
300	3,20	2,20	30	2/7/42 + 2/9/46,5 + 2/10/60	96	W	15.300.30.96	146,00 CHF
NEU 315	3,20	2,20	30	2/7/42 + 2/9/46,5 + 2/10/60	96	W	15.315.30.96	156,00 CHF
350	3,50	2,50	30	2/7/42 + 2/9/46,5 + 2/10/60	108	W	15.350.30.108	177,00 CHF

## Holzwerkstoffkreissägeblatt

Lames pour scie à panneaux



ANWENDUNG

Formatbearbeitung. Längsschnitt, Querschnitt

WERKSTOFF

Holzwerkstoff roh und beschichtet, Duroplast

MASCHINE

Tisch- und Formatkreissäge

ZAHN

Flach-Trapezzahn (FT), HW

UTILISATION

Scie à format, coupe en long et en travers

MATERIAU

Panneaux agglo et MDF revêtus, Duroplast

MACHINE

Scie à panneaux verticale, scie à format

DENTURE

Plate-Trapézoïdale (PT), HW

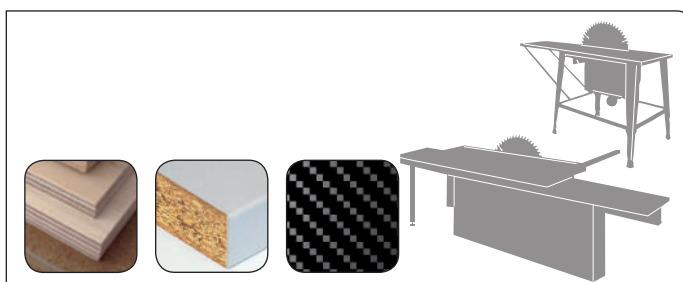
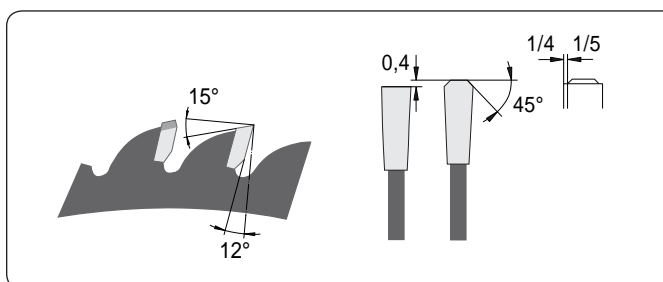

	D mm	B mm	b mm	d mm	NL/TK mm TE	Z	Zahnform Denture	Bestellnummer Références	Preis Prix
NEU	220	3,20	2,20	30	2/7/42 + 2/9/46,5 + 2/10/60	64	FT	21.220.30.64	115,00 CHF
	250	3,20	2,20	30	2/7/42 + 2/9/46,5 + 2/10/60	60	FT	21.250.30.60	112,00 CHF
	250	3,20	2,20	30	2/7/42 + 2/9/46,5 + 2/10/60	80	FT	21.250.30.80	126,00 CHF
	300	3,20	2,20	30	2/7/42 + 2/9/46,5 + 2/10/60	72	FT	21.300.30.72	137,00 CHF
	300	3,20	2,20	30	2/7/42 + 2/9/46,5 + 2/10/60	96	FT	21.300.30.96	155,00 CHF
NEU	350	3,50	2,50	30	2/7/42 + 2/9/46,5 + 2/10/60	84	FT	21.350.30.84	175,00 CHF
	350	3,50	2,50	30	2/7/42 + 2/9/46,5 + 2/10/60	108	FT	21.350.30.108	194,00 CHF

## Holzwerkstoffkreissägeblatt - Hohlzahn

Lames pour scie à panneaux - Denture gouge positive



ANWENDUNG	Für beschichtete Einzelplatte
WERKSTOFF	Holzwerkstoff beschichtet, Thermoplast
MASCHINE	Plattenaufteilsäge vertikal, Tisch- und Formatkreissäge
ZAHN	Hohl-Dach-Flach (HD), HW
UTILISATION	Coupe de finition à l'unité
MATERIAU	Panneaux agglo et MDF revêtus 2 faces, Thermoplast
MACHINE	Scie à panneaux verticale, scie à format
DENTURE	Gouge plate-toit positive (HD), HW

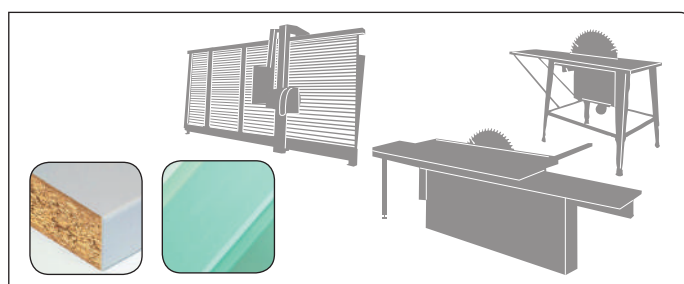
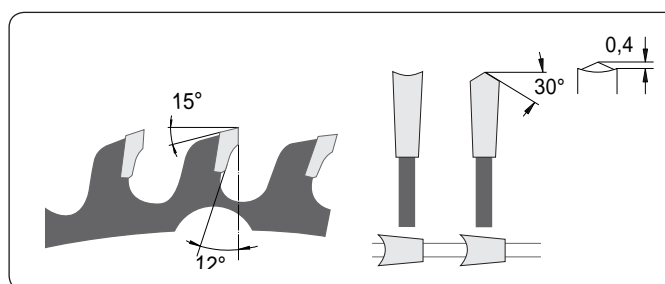

	D mm	B mm	b mm	d mm	NL/TK mm TE	Z	Zahnform Denture	Bestellnummer Références	Preis Prix
NEU	160	2,80	1,80	20	2/6/32	34	HD	25.160.20.34	89,00 CHF
NEU	190	2,80	1,80	30	2/7/42	38	HD	25.190.30.38	102,00 CHF
NEU	200	2,80	1,80	30	2/7/42	40	HD	25.200.30.40	106,00 CHF
NEU	220	3,20	2,20	30	2/7/42 + 2/9/46,5 + 2/10/60	44	HD	25.220.30.44	114,00 CHF
	250	3,20	2,20	30	2/7/42 + 2/9/46,5 + 2/10/60	48	HD	25.250.30.48	124,00 CHF
	303	3,20	2,20	30	2/7/42 + 2/9/46,5 + 2/10/60	60	HD	25.303.30.60	135,00 CHF
	350	3,20	2,20	30	2/7/42 + 2/9/46,5 + 2/10/60	72	HD	25.350.30.72	190,00 CHF

## Holzwerkstoffkreissägeblatt – Hohlzahn, negativ

Lames pour scie à panneaux - Denture gouge négative



ANWENDUNG  
WERKSTOFF  
MASCHINE  
ZAHN  
UTILISATION  
MATERIAU  
MACHINE  
DENTURE

Für beschichtete Einzelplatte  
Holzwerkstoff beschichtet, Thermoplast  
Plattenaufteilsäge vertikal, Tisch- und Formatkreissäge  
Hohl-Dach-Flach (HD) negativ, HW  
Coupe de finition à l'unité  
Panneaux aggro et MDF revêtus 2 faces  
Scie à panneaux verticale, scie à format  
Gouge plate-toit négative (HD), HW

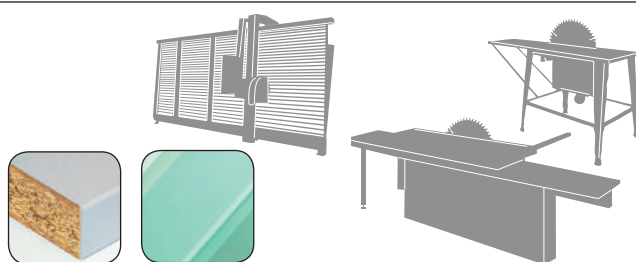
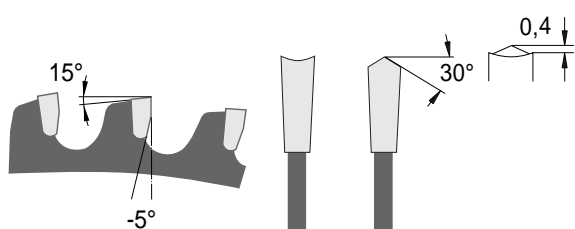

D mm	B mm	b mm	d mm	NL/TK mm TE	Z	Zahnform Denture	Bestellnummer Références	Preis Prix
220	3,20	2,20	30	2/7/42 + 2/9/46,5 + 2/10/60	44	HD, neg.	27.220.30.44	114,00 CHF
250	3,20	2,20	30	2/7/42 + 2/9/46,5 + 2/10/60	48	HD, neg.	27.250.30.48	124,00 CHF
303	3,20	2,20	30	2/7/42 + 2/9/46,5 + 2/10/60	60	HD, neg.	27.303.30.60	135,00 CHF
350	3,20	2,20	30	2/7/42 + 2/9/46,5 + 2/10/60	72	HD, neg.	27.350.30.72	190,00 CHF

## Kreissägeblatt Wechselzahn extrem, 35°

Lames alternées 35°



ANWENDUNG  
WERKSTOFF  
MASCHINE  
ZAHN  
UTILISATION  
MATERIAU  
MACHINE  
DENTURE

Formatbearbeitung in Holzwerkstoff,  
Querschnitte in Massivholz  
Holzwerkstoff roh und beschichtet, Massivholz  
Tisch- und Formatkreissäge  
Wechselzahn 35° (W 35°) negativ, HW  
Scie à format panneaux aggro et MDF,  
coupe en travers dans le bois massif  
Panneaux aggro et MDF revêtus, Bois massif  
Scie à format  
Alternée 35° (W 35°) négative, HW

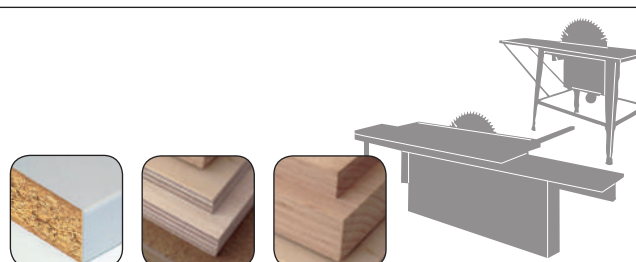
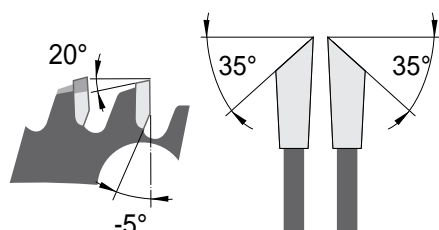

D mm	B mm	b mm	d mm	NL/TK mm TE	Z	Zahnform Denture	Bestellnummer Références	Preis Prix
250	3,20	2,20	30	2/7/42 + 2/9/46,5 + 2/10/60	80	W 35°, neg.	19.250.30.80	131,00 CHF
300	3,20	2,20	30	2/7/42 + 2/9/46,5 + 2/10/60	96	W 35°, neg.	19.300.30.96	160,00 CHF
350	3,50	2,50	30	2/7/42 + 2/9/46,5 + 2/10/60	108	W 35°, neg.	19.350.30.108	194,00 CHF

# Handkreissägeblatt

Lames pour machines portatives



ANWENDUNG	Querschnitt und Längsschnitt mit Wechselzahn (W) oder mit Flach-Trapezzahn (FT)
WERKSTOFF	Massivholz, Holzwerkstoff, Kunststoff
MASCHINE	Handkreissäge, Tischkreissäge
ZAHN	Wechselzahn (W), Flach-Trapezzahn (FT), HW
UTILISATION	Coupe en long et en travers en denture alternée (W) ou en Plate-Trapézoïdale (PT)
MATERIAU	Bois massif, panneaux, etc.
MACHINE	Portatives, scie de table, scie à tronçonner
DENTURE	Alternée (W), Plate-Trapézoïdale (PT), HW

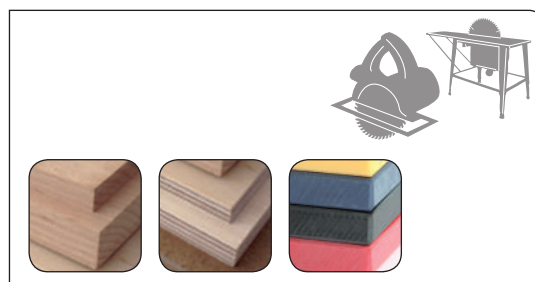
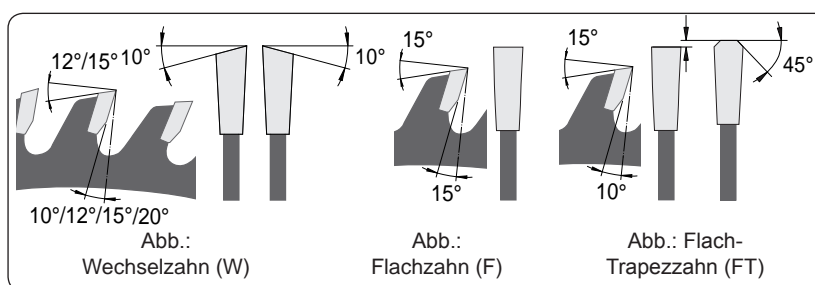

D mm	B mm	b mm	d mm	NL/TK mm TE	Maschine Machine	Z	Zahnform Denture	Bestellnummer Références	Preis Prix
NEU 85	1,10	0,70	15		Bosch	20	W	47.085.15.20	49,00 CHF
86	2,60	1,60	12			12	W	47.086.12.12	34,00 CHF
100	2,60	1,60	12			12	W	47.100.12.12	35,00 CHF
100	2,60	1,60	12			30	W	47.100.12.30	49,00 CHF
105	2,60	1,60	20			30	W	47.105.20.30	50,00 CHF
105	2,60	1,60	22			30	W	47.105.22.30	50,00 CHF
120	1,80	1,20	20		Mafell	12	W	47.120.20.12	34,00 CHF
120	1,80	1,20	20		Mafell	24	W	47.120.20.24	42,00 CHF
120	2,60	1,60	20			30	W	47.120.20.30	51,00 CHF
120	1,80	1,20	20		Mafell	40	FT	21.120.20.40	64,00 CHF
125	2,60	1,60	12,75	2/6,5/76		12	W	47.125.12.12	35,00 CHF
125	2,60	1,60	20	2/6/32		12	W	47.125.20.12	35,00 CHF
125	2,60	1,60	12,75	2/6,5/76		30	W	47.125.12.30	50,00 CHF
125	2,60	1,60	20	2/6/32		30	W	47.125.20.30	50,00 CHF
130	2,60	1,60	16			24	W	47.130.16.24	42,00 CHF
130	2,60	1,60	20			24	W	47.130.20.24	42,00 CHF
130	2,60	1,60	16			36	W	47.130.16.36	56,00 CHF
NEU 130	2,60	1,60	20			36	W	47.130.20.36	56,00 CHF
132	2,60	1,60	20			12	W	47.132.20.12	35,00 CHF
134	2,60	1,60	20			24	W	47.134.20.24	42,00 CHF
134	2,60	1,60	20			36	W	47.134.20.36	54,00 CHF
136	1,50	1,10	10		DeWalt	16	W	47.136.10.16	34,00 CHF
136	1,50	1,00	20		Makita	16	W	47.136.20.16	34,00 CHF
136	1,50	1,10	10		DeWalt	24	W	47.136.10.24	39,00 CHF
136	1,50	1,00	20		Makita	24	W	47.136.20.24	39,00 CHF

## Handkreissägeblatt

Lames pour machines portatives

D mm	B mm	b mm	d mm	NL/TK mm TE	Maschine Machine	Z	Zahnform Denture	Bestellnummer Références	Preis Prix	
140	2,60	1,60	12,75	2/6,5/88		12	W	47.140.12.12	36,00 CHF	
140	2,60	1,60	13			12	W	47.140.13.12	36,00 CHF	
140	2,60	1,60	20	2/6/32		12	W	47.140.20.12	36,00 CHF	
140	2,60	1,60	12,75	2/6,5/88		24	W	47.140.12.24	42,00 CHF	
140	2,60	1,60	20	2/6/32		24	W	47.140.20.24	42,00 CHF	
140	2,60	1,60	20	2/6/32		30	W	47.140.20.30	51,00 CHF	
140	2,60	1,60	12,75	2/6,5/88		36	W	47.140.12.36	59,00 CHF	
150	2,60	1,60	16			12	W	47.150.16.12	36,00 CHF	
150	2,60	1,60	30	2/7/42		12	W	47.150.30.12	36,00 CHF	
150	2,60	1,60	20	2/6/32		18	W	47.150.20.18	41,00 CHF	
150	2,60	1,60	16			30	W	47.150.16.30	50,00 CHF	
150	2,60	1,60	20	2/6/32		30	W	47.150.20.30	50,00 CHF	
150	2,60	1,60	30	2/7/42		30	W	47.150.30.30	50,00 CHF	
150	2,60	1,60	16			48	W	47.150.16.48	71,00 CHF	
150	2,60	1,60	20	2/6/32		48	W	47.150.20.48	71,00 CHF	
150	2,60	1,60	30	2/7/42		48	W	47.150.30.48	71,00 CHF	
160	2,60	1,60	16	2/6/33		12	W	47.160.16.12	36,00 CHF	
160	2,20	1,80	20	2/6/32	Festool	12	W	47.160.20.12.B22	36,00 CHF	
160	2,60	1,60	20	2/6/32		12	W	47.160.20.12.B26	36,00 CHF	
160	2,60	1,60	30	2/7/42		12	W	47.160.30.12	36,00 CHF	
NEU	160	1,60	1,10	20	2/6/32	Mafell	F/Fa	47.160.20.16.B16	41,00 CHF	
160	1,80	1,20	20	2/6/32	Mafell	16	W	47.160.20.16.B18	40,00 CHF	
NEU	160	2,20	1,60	20	2/6/32	Festool	18	W	47.160.20.18	42,00 CHF
160	2,60	1,60	16	2/6/33		24	W	47.160.16.24	45,00 CHF	
160	1,80	1,20	20	2/6/32	Mafell, Bosch	24	W	47.160.20.24.B18	41,00 CHF	
160	2,60	1,60	20	2/6/32		24	W	47.160.20.24.B26	45,00 CHF	
160	2,60	1,60	30	2/7/42		24	W	47.160.30.24	45,00 CHF	
160	2,20	1,80	20	2/6/32	Festool	28	W	47.160.20.28	48,00 CHF	
160	2,60	1,60	20	2/6/32		30	W	47.160.20.30	51,00 CHF	
160	1,80	1,20	20	2/6/32	Mafell	32	W	47.160.20.32	53,00 CHF	
160	2,60	1,60	16	2/6/33		36	W	47.160.16.36	59,00 CHF	
160	2,60	1,60	20	2/6/32		36	W	47.160.20.36	59,00 CHF	
160	2,60	1,60	30	2/7/42		36	W	47.160.30.36	59,00 CHF	
160	2,60	1,60	16	2/6/33		48	W	47.160.16.48	66,00 CHF	
160	1,80	1,20	20	2/6/32	Mafell	48	FT	21.160.20.48.B18	64,00 CHF	
NEU	160	2,20	1,60	20	2/6/32	Festool	48	FT	21.160.20A.48	66,00 CHF
160	2,20	1,80	20	2/6/32	Festool	48	W	47.160.20.48.B22	63,00 CHF	
160	2,60	1,60	20	2/6/32		48	W	47.160.20.48.B26	66,00 CHF	
160	2,60	1,60	30	2/7/42		48	W	47.160.30.48	66,00 CHF	
NEU	160	1,80	1,20	20	2/6/32	Mafell	56	FT	21.160.20.56	81,00 CHF
165	2,60	1,60	16	2/6/33		12	W	47.165.16.12	37,00 CHF	
165	2,40	1,40	20			12	W	47.165.20.12	37,00 CHF	
NEU	165	1,80	1,30	20		20	W	47.165.20.20	42,00 CHF	
165	1,50	1,10	10		Bosch	24	W	47.165.10.24	43,00 CHF	
165	2,60	1,60	16	2/6/33	DeWalt	24	W	47.165.16.24	43,00 CHF	
165	1,50	1,00	20		Makita	24	W	47.165.20.24.B15	43,00 CHF	
165	2,40	1,40	20			24	W	47.165.20.24.B24	43,00 CHF	
165	2,60	1,60	16	2/6/33		30	W	47.165.16.30	51,00 CHF	
165	2,60	1,60	20			30	W	47.165.20.30	51,00 CHF	



## Handkreissägeblatt

Lames pour machines portatives

	D mm	B mm	b mm	d mm	NL/TK mm TE	Maschine Machine	Z	Zahnform Denture	Bestellnummer Références	Preis Prix
NEU	165	1,80	1,30	20		Bosch	32	W	47.165.20.32	53,00 CHF
	165	1,50	1,10	10		DeWalt	48	W	47.165.10.48	72,00 CHF
	165	1,50	1,00	20		Makita	48	W	47.165.20.48.B15	72,00 CHF
NEU	165	1,80	1,30	20		Bosch	48	W	47.165.20.48.B18	72,00 CHF
NEU	165	1,80	1,30	20		Bosch	48	FT	21.165.20A.48	73,00 CHF
	165	2,30	1,80	20			48	W	47.165.20.48.B23	72,00 CHF
	165	2,40	1,40	20			48	W	47.165.20.48.B24	72,00 CHF
	170	2,60	1,60	30	2/7/42		12	W	47.170.30.12	37,00 CHF
	170	2,60	1,60	30	2/7/42		24	W	47.170.30.24	47,00 CHF
	170	2,60	1,60	30	2/7/42		30	W	47.170.30.30	52,00 CHF
	170	2,60	1,60	30	2/7/42		48	W	47.170.30.48	75,00 CHF
NEU	180	2,80	1,80	20	2/6/32		12	W	47.180.20.12	45,00 CHF
	180	2,80	1,80	30	2/7/42		12	W	47.180.30.12	45,00 CHF
	180	2,80	1,80	16	2/6/33		24	W	47.180.16.24	47,00 CHF
	180	2,80	1,80	20	2/6/32		24	W	47.180.20.24	47,00 CHF
	180	2,80	1,80	30	2/7/42		24	W	47.180.30.24	47,00 CHF
	180	2,80	1,80	16	2/6/33		30	W	47.180.16.30	52,00 CHF
	180	2,80	1,80	20	2/6/32		30	W	47.180.20.30	52,00 CHF
NEU	180	2,00	1,20	30	2/7/42	Mafell	30	W	47.180.30.30.B20	52,00 CHF
	180	2,80	1,80	30	2/7/42		30	W	47.180.30.30.B28	52,00 CHF
NEU	180	2,80	1,80	20	2/6/32		42	W	47.180.20.420	65,00 CHF
	180	2,80	1,80	16	2/6/33		54	W	47.180.16.54	78,00 CHF
	180	2,80	1,80	20	2/6/32		54	W	47.180.20.54	78,00 CHF
NEU	180	2,00	1,20	30	2/7/42	Mafell	56	W	47.180.30.56	79,00 CHF
	184	2,60	1,60	20			18	W	47.184.20.18	42,00 CHF
	184	1,80	1,20	20		DeWalt	24	W	47.184.20.24	45,00 CHF
	184	2,80	1,80	16			30	W	47.184.16.30	52,00 CHF
	184	2,60	1,60	20			30	W	47.184.20.30	52,00 CHF
	190	2,80	1,80	16	2/6/32		16	W	47.190.16.16	43,00 CHF
	190	2,80	1,80	20	2/6/32		16	W	47.190.20.16	43,00 CHF
	190	2,80	1,80	30	2/7/42	Mafell, Festool	16	W	47.190.30.16	43,00 CHF
NEU	190	2,60	1,80	FastFix		Festool	16	W	47.190.16.FF	43,00 CHF
	190	2,80	1,80	16	2/6/32		24	W	47.190.16.24	49,00 CHF
	190	2,80	1,80	20	2/6/32		24	W	47.190.20.24	49,00 CHF
	190	2,50	1,80	30	2/7/42	Mafell	24	W	47.190.30.24.B25	49,00 CHF
	190	2,80	1,80	30	2/7/42		24	W	47.190.30.24.B28	49,00 CHF
	190	2,80	1,80	16	2/6/32		30	W	47.190.16.30	52,00 CHF
	190	2,80	1,80	20	2/6/32		30	W	47.190.20.30	52,00 CHF
	190	2,80	1,80	30	2/7/42		30	W	47.190.30.30	52,00 CHF
NEU	190	2,80	1,80	30	2/7/42	Festool	32	W	47.190.30.32	57,00 CHF
NEU	190	2,60	1,80	FastFix		Festool	32	W	47.190.32.FF	57,00 CHF
	190	2,00	1,20	30	2/7/42	Mafell	36	W	47.190.30.36	63,00 CHF
NEU	190	2,80	1,80	16	2/6/32		48	W	47.190.16.48	77,00 CHF
	190	2,80	1,80	20	2/6/32		48	W	47.190.20.48	77,00 CHF
	190	2,80	1,80	30	2/7/42	Festool	48	W	47.190.30.48	77,00 CHF
NEU	190	2,40	1,80	FastFix		Festool	48	W	47.190.48.FF	77,00 CHF
NEU	190	2,60	1,80	30	2/7/42	Festool	54	FT	21.190.30.54	87,00 CHF
NEU	190	2,60	1,80	FastFix		Festool	54	FT	21.190.54.FF	87,00 CHF
	190	2,80	1,80	16	2/6/32		56	W	47.190.16.56	81,00 CHF
	190	2,80	1,80	30	2/7/42		56	W	47.190.30.56	81,00 CHF

## Handkreissägeblatt

Lames pour machines portatives

D mm	B mm	b mm	d mm	NL/TK mm TE	Maschine Machine	Z	Zahnform Denture	Bestellnummer Références	Preis Prix	
200	2,80	1,80	16	2/7/42		16	W	47.200.16.16	47,00 CHF	
200	2,80	1,80	30	2/7/42		16	W	47.200.30.16	47,00 CHF	
200	2,80	1,80	16	2/7/42		24	W	47.200.16.24	55,00 CHF	
200	2,80	1,80	30	2/7/42		24	W	47.200.30.24	55,00 CHF	
200	2,80	1,80	15	2/7/42		30	W	47.200.15.30	60,00 CHF	
200	2,80	1,80	20	2/7/42		30	W	47.200.20.30	60,00 CHF	
200	2,80	1,80	30	2/7/42		30	W	47.200.30.30	60,00 CHF	
200	2,80	1,80	16	2/7/42		48	W	47.200.16.48	80,00 CHF	
200	2,80	1,80	30	2/7/42		48	W	47.200.30.48	80,00 CHF	
200	2,80	1,80	16	2/7/42		64	W	47.200.16.64	97,00 CHF	
200	2,80	1,80	30	2/7/42		64	W	47.200.30.64	97,00 CHF	
210	2,80	1,80	30	2/7/42		16	F	47.210.30.16	47,00 CHF	
NEU	210	2,60	1,80	30	2/7/42	Festool	18	W	47.210.30.18	50,00 CHF
	210	2,80	1,80	30	2/7/42		24	W	47.210.30.24	55,00 CHF
	210	2,80	1,80	16	2/7/42		30	W	47.210.16.30	63,00 CHF
	210	2,80	1,80	30	2/7/42		30	W	47.210.30.30	63,00 CHF
NEU	210	2,40	1,80	30	2/7/42	Festool	36	W	47.210.30.36	72,00 CHF
	210	2,80	1,80	30	2/7/42		48	W	47.210.30.48	83,00 CHF
NEU	210	2,40	1,80	30	2/7/42	Festool	52	W	47.210.30.52	93,00 CHF
NEU	210	2,40	1,80	30	2/7/42	Festool	60	FT	21.210.30.60	99,00 CHF
	210	2,80	1,80	30	2/7/42		64	W	47.210.30.64	97,00 CHF
	215	3,00	2,00	30	2/7/42		24	W	47.215.30.24	57,00 CHF
	215	3,00	2,00	30	2/7/42		48	W	47.215.30.48	87,00 CHF
	220	3,00	2,00	30	2/7/42		24	W	47.220.30.24	57,00 CHF
	220	3,00	2,00	30	2/7/42		30	W	47.220.30.30	66,00 CHF
	220	3,00	2,00	30	2/7/42		48	W	47.220.30.48	85,00 CHF
	220	3,00	2,00	30	2/7/42		64	W	47.220.30.64	99,00 CHF
NEU	225	2,60	1,80	30	2/7/42	Festool	18	W	47.225.30.18	53,00 CHF
	225	3,00	2,00	30	2/7/42		24	W	47.225.30.24	57,00 CHF
	225	3,00	2,00	30	2/7/42		30	W	47.225.30.30	66,00 CHF
	225	2,50	1,80	30	2/7/42	Mafell, Festool	32	W	47.225.30.32	65,00 CHF
	225	2,50	1,80	30	2/7/42	Mafell, Festool	48	W	47.225.30.48.B25	87,00 CHF
	225	3,00	2,00	30	2/7/42		48	W	47.225.30.48.B30	87,00 CHF
	225	2,50	1,80	30	2/7/42	Mafell	56	FT	21.225.30.56	94,00 CHF
NEU	225	2,60	1,80	30	2/7/42	Festool	64	FT	21.225.30.64	102,00 CHF
NEU	230	2,50	1,80	30	2/7/42	Mafell	12	W	47.230.30.12	46,00 CHF
	230	3,00	2,00	16	2/7/42		24	W	47.230.16.24	57,00 CHF
	230	2,50	1,80	30	2/7/42	Mafell	24	W	47.230..3024.B25	57,00 CHF
	230	3,00	2,00	30	2/7/42		24	W	47.230.30.24.B30	57,00 CHF
	230	3,00	2,00	30	2/7/42		30	W	47.230.30.30	66,00 CHF
	230	3,00	2,00	16	2/7/42		48	W	47.230.16.48	87,00 CHF
	230	3,00	2,00	30	2/7/42		48	W	47.230.30.48	87,00 CHF
NEU	230	2,60	1,80	30	2/7/42	Mafell	56	W	47.230.30.56	93,00 CHF
	230	3,00	2,00	30	2/7/42		64	W	47.230.30.64	98,00 CHF
	235	3,00	2,00	25	2/7/42		24	W	47.235.25.24	58,00 CHF
	235	3,00	2,00	30	2/7/42		24	W	47.235.30.24	58,00 CHF
	235	3,00	2,00	30	2/7/42		30	W	47.235.30.30	66,00 CHF
	235	3,00	2,00	30	2/7/42		48	W	47.235.30.48	87,00 CHF

## Handkreissägeblatt

Lames pour machines portatives

	D mm	B mm	b mm	d mm	NL/TK mm TE	Maschine Machine	Z	Zahnform Denture	Bestellnummer Références	Preis Prix
NEU	237	2,50	1,80	30		Mafell	12	W	47.237.30.12	48,00 CHF
NEU	237	2,50	1,80	30		Mafell	24	W	47.237.30.24	59,00 CHF
NEU	237	2,50	1,80	30		Mafell	56	W	47.237.30.56	88,00 CHF
	240	3,00	2,00	30	2/7/42		24	W	47.240.30.24	60,00 CHF
	240	3,00	2,00	30	2/7/42		30	W	47.240.30.30	66,00 CHF
	240	3,00	2,00	30	2/7/42		56	W	47.240.30.56	93,00 CHF
NEU	250	3,20	2,20	30	2/7/42 + 2/9/46,5 + 2/10/60		24	W	47.250.30.24	65,00 CHF
	250	3,20	2,20	20	2/7/42 + 2/9/46,5 + 2/10/60		30	W	47.250.20.30	73,00 CHF
	250	3,20	2,20	30	2/7/42 + 2/9/46,5 + 2/10/60		30	W	47.250.30.30	73,00 CHF
	250	3,20	2,20	20	2/7/42 + 2/9/46,5 + 2/10/60		40	W	47.250.20.40	88,00 CHF
	260	3,00	2,00	30	2/7/42 + 2/9/46,5 + 2/10/60		24	W	47.260.30.24	64,00 CHF
	260	3,20	2,20	30	2/7/42 + 2/9/46,5 + 2/10/60		42	W	47.260.30.42	91,00 CHF
	270	3,20	2,20	30	2/7/42 + 2/9/46,5 + 2/10/60		24	W	47.270.30.24	79,00 CHF
	270	3,00	2,00	30	2/7/42 + 2/9/46,5 + 2/10/60		48	W	47.270.30.48	98,00 CHF
	280	3,20	2,20	30	2/7/42 + 2/9/46,5 + 2/10/60		28	W	47.280.30.28	82,00 CHF
	280	3,20	2,20	30	2/7/42 + 2/9/46,5 + 2/10/60	Mafell	48	W	47.280.30.48	104,00 CHF
	280	3,20	2,20	30	2/7/42 + 2/9/46,5 + 2/10/60		60	W	47.280.30.60	114,00 CHF
	280	3,20	2,20	30	2/7/42 + 2/9/46,5 + 2/10/60		80	W	47.280.30.80	126,00 CHF
	300	3,20	2,20	30	2/7/42 + 2/9/46,5 + 2/10/60		30	W	47.300.30.30	84,00 CHF
NEU	315	3,20	2,20	30	2/7/42 + 2/9/46,5 + 2/10/60	Mafell	16	W	47.315.30.16	77,00 CHF
NEU	315	3,20	2,20	30	2/7/42 + 2/9/46,5 + 2/10/60	Mafell	28	W, SDB	10.315.30.28	83,00 CHF
–	315	3,20	2,20	30	2/7/42 + 2/9/46,5 + 2/10/60	Mafell	28	W	47.315.30.28	87,00 CHF
NEU	330	3,20	2,20	30	2/7/42 + 2/9/46,5 + 2/10/60	Mafell	24	W, SDB	47.330.30.24	86,00 CHF
NEU	330	3,60	2,20	30	2/7/42 + 2/9/46,5 + 2/10/60	Mafell	40	W, SDB	47.330.30.40	111,00 CHF
	335	3,20	2,20	25	2/7/42 + 2/9/46,5 + 2/10/60		30	W, SDB	47.335.25.30	89,00 CHF
NEU	355	3,20	2,20	30	2/7/42 + 2/9/46,5 + 2/10/60	Mafell	16	W, SDB	47.355.30.16	81,00 CHF
–	355	3,20	2,20	30	2/7/42 + 2/9/46,5 + 2/10/60		30	W, SDB	47.355.30.30	89,00 CHF
NEU	355	3,20	2,20	30	2/7/42 + 2/9/46,5 + 2/10/60	Mafell	32	W, SDB	47.355.30.32	103,00 CHF
NEU	370	4,20	2,20	30	2/7/42 + 2/9/46,5 + 2/10/60	Mafell	18	W, SDB	47.370.30.18	92,00 CHF
–	370	3,60	2,50	30	2/7/42 + 2/9/46,5 + 2/10/60		26	W, SDB	47.370.30.26.B36	105,00 CHF
NEU	370	4,20	2,20	30	2/7/42 + 2/9/46,5 + 2/10/60	Mafell	26	W, SDB	47.370.30.26.B42	108,00 CHF
NEU	410	4,20	2,50	30	2/7/42 + 2/9/46,5 + 2/10/60	Mafell	20	W, SDB	47.410.30.20	121,00 CHF
–	410	3,60	2,50	30	2/7/42 + 2/9/46,5 + 2/10/60		28	W, SDB	47.410.30.28.B36	140,00 CHF
NEU	410	4,20	2,50	30	2/7/42 + 2/9/46,5 + 2/10/60	Mafell	28	W, SDB	47.410.30.28.B42	133,00 CHF
NEU	450	3,80	2,50	30	2/7/42 + 2/9/46,5 + 2/10/60	Mafell	12	W, SDB	47.450.30.12	108,00 CHF
NEU	450	4,20	2,50	30	2/7/42 + 2/9/46,5 + 2/10/60	Mafell	20	W, SDB	47.450.30.20	125,00 CHF
NEU	450	4,50	2,50	30	2/7/42 + 2/9/46,5 + 2/10/60	Mafell	34	W, SDB	47.450.30.34	143,00 CHF

## Handkreissägeblatt mit extra dünner Schnittfuge

Lames avec trait de scie extra mince

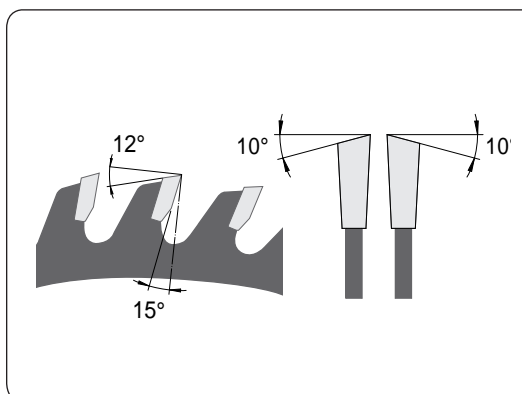

### ANWENDUNG

Querschnitt, Längsschnitt  
(vorzugsweise in dünnen Materialien)

### WERKSTOFF

Massivholz, Holzwerkstoff

### MASCHINE

Handkreissäge, Tischkreissäge

### ZAHN

Wechselzahn (W), HW

### UTILISATION

Coupe en long et en travers

### MATERIAU

Bois massif, panneaux

### MACHINE

Portatives, scie de table, scie à tronçonner

### DENTURE

Alternée (W), HW

D mm	B mm	b mm	d mm	NL/TK mm TE	Z	Zahnform Denture	Bestellnummer Références	Preis Prix
160	1,20	0,80	30		60	W	47.160.30.60	151,00 CHF
180	1,20	0,80	30		60	W	47.180.30.60	155,00 CHF
200	1,20	0,80	30		60	W	47.200.30.60	160,00 CHF

## Nutfräser für Lamellen

Fraise à rainer



### ANWENDUNG

Zum Einnuten von  
Lamellen Verbindungsplättchen

### WERKSTOFF

Massivholz, Holzwerkstoff roh und beschichtet

### MASCHINE

Handmaschine

### ZAHN

Wechsel-Wechsel-Flachzahn (WWF), HW

### UTILISATION

Rainer pour insères

### MATERIAU

Bois massif, Panneaux aggro et MDF revêtus

### MACHINE

Machines portatives

### DENTURE

Gauche-droite-plat (WWF), HW

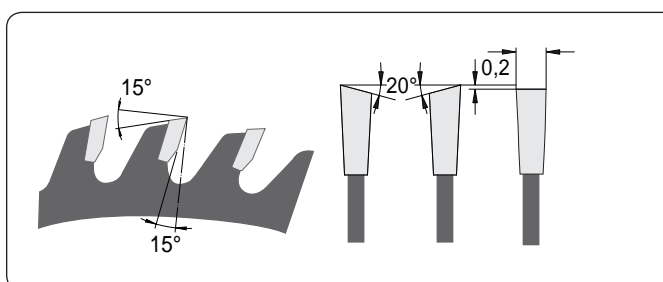

D mm	B mm	b mm	d mm	Einsatz	Z	Zahnform Denture	Bestellnummer Références	Preis Prix
100	3,97	2,80	22	für Lamellen	6	WWF	47.100.22.06	42,00 CHF
100	3,97	2,80	22	für Lamellen	9	WWF	47.100.22.09	53,00 CHF

# Spezialabmessungen für Mafell®-Maschinen

## Lames pour machines portatives Mafell®

	D mm	B mm	b mm	d mm	NL mm TE	Z	Zahnform Denture	Bestellnummer Références	Preis Prix
	120	1,80	1,20	20		12	W	47.120.20.12	34,00 CHF
	120	1,80	1,20	20		24	W	47.120.20.24	42,00 CHF
	120	1,80	1,20	20		40	FT	21.120.20.40	64,00 CHF
NEU	160	1,60	1,10	20	2/6/32	16	F/Fa	47.160.20.16.B16	41,00 CHF
	160	1,80	1,20	20	2/6/32	16	W	47.160.20.16.B18	40,00 CHF
	160	1,80	1,20	20	2/6/32	24	W	47.160.20.24.B18	41,00 CHF
	160	1,80	1,20	20	2/6/32	32	W	47.160.20.32	53,00 CHF
	160	1,80	1,20	20	2/6/32	48	FT	21.160.20.48.B18	64,00 CHF
NEU	160	1,80	1,20	20	2/6/32	56	FT	21.160.20.56	81,00 CHF
NEU	180	2,00	1,20	30	2/7/42	30	W	47.180.30.30.B20	52,00 CHF
NEU	180	2,00	1,20	30	2/7/42	56	W	47.180.30.56	79,00 CHF
	190	2,80	1,80	30	2/7/42	16	W	47.190.30.16	43,00 CHF
	190	2,50	1,80	30	2/7/42	24	W	47.190.30.24.B25	49,00 CHF
	190	2,00	1,20	30	2/7/42	36	W	47.190.30.36	63,00 CHF
	225	2,50	1,80	30	2/7/42	32	W	47.225.30.32	65,00 CHF
	225	2,50	1,80	30	2/7/42	48	W	47.225.30.48.B25	87,00 CHF
	225	2,50	1,80	30	2/7/42	56	FT	21.225.30.56	94,00 CHF
NEU	225	2,50	1,80	30	2/7/42 + 2/9/46,5 + 2/10/60	68	FT, neg.	42.225.30.68.B25	121,00 CHF
NEU	230	2,50	1,80	30	2/7/42	12	W	47.230.30.12	46,00 CHF
	230	2,50	1,80	30	2/7/42	24	W	47.230.30.24.B25	57,00 CHF
	230	2,60	1,80	30	2/7/42	56	W	47.230.30.56	93,00 CHF
NEU	237	2,50	1,80	30		12	W	47.237.30.12	48,00 CHF
NEU	237	2,50	1,80	30		24	W	47.237.30.24	59,00 CHF
NEU	237	2,50	1,80	30		56	W	47.237.30.56	88,00 CHF
	280	3,20	2,20	30	2/7/42 + 2/9/46,5 + 2/10/60	48	W	47.280.30.48	104,00 CHF
NEU	315	3,20	2,20	30	2/7/42 + 2/9/46,5 + 2/10/60	16	W	47.315.30.16	77,00 CHF
NEU	315	3,20	2,20	30	2/7/42 + 2/9/46,5 + 2/10/60	28	W, SDB	10.315.30.28	83,00 CHF
-	315	3,20	2,20	30	2/7/42 + 2/9/46,5 + 2/10/60	28	W	47.315.30.28	87,00 CHF
NEU	330	3,20	2,20	30	2/7/42 + 2/9/46,5 + 2/10/60	24	W, SDB	47.330.30.24	86,00 CHF
NEU	330	3,60	2,20	30	2/7/42 + 2/9/46,5 + 2/10/60	40	W, SDB	47.330.30.40	111,00 CHF
NEU	355	3,20	2,20	30	2/7/42 + 2/9/46,5 + 2/10/60	16	W, SDB	47.355.30.16	81,00 CHF
NEU	355	3,20	2,20	30	2/7/42 + 2/9/46,5 + 2/10/60	32	W, SDB	47.355.30.32	103,00 CHF
NEU	370	4,20	2,20	30	2/7/42 + 2/9/46,5 + 2/10/60	18	W, SDB	47.370.30.18	92,00 CHF
NEU	370	4,20	2,20	30	2/7/42 + 2/9/46,5 + 2/10/60	26	W, SDB	47.370.30.26	108,00 CHF
NEU	410	4,20	2,50	30	2/7/42 + 2/9/46,5 + 2/10/60	20	W, SDB	47.410.30.20	121,00 CHF
NEU	410	4,20	2,50	30	2/7/42 + 2/9/46,5 + 2/10/60	28	W, SDB	47.410.30.28	133,00 CHF
NEU	450	3,80	2,50	30	2/7/42 + 2/9/46,5 + 2/10/60	12	W, SDB	47.450.30.12	108,00 CHF
NEU	450	4,20	2,50	30	2/7/42 + 2/9/46,5 + 2/10/60	20	W, SDB	47.450.30.20	125,00 CHF
NEU	450	4,50	2,50	30	2/7/42 + 2/9/46,5 + 2/10/60	34	W, SDB	47.450.30.34	143,00 CHF

# Spezialabmessungen für Festool®-Maschinen

## Lames pour machines portatives Festool®

D mm	B mm	b mm	d mm	NL mm TE	Z	Zahnform Denture	Bestellnummer Références	Preis Prix	
160	2,20	1,80	20	2/6/32	12	W	47.160.20.12.B22	36,00 CHF	
NEU	160	2,20	1,60	20	2/6/32	18	W	47.160.20.18	42,00 CHF
160	2,20	1,80	20	2/6/32	28	W	47.160.20.28	48,00 CHF	
NEU	160	2,20	1,60	20	2/6/32	48	FT	47.160.20A.48	66,00 CHF
160	2,20	1,80	20	2/6/32	48	W	47.160.20.48.B22	63,00 CHF	
NEU	160	2,20	1,60	20	2/6/32	52	FT, neg.	42.160.20.52	85,00 CHF
190	2,80	1,80	30	2/7/42	16	W	47.190.30.16	43,00 CHF	
NEU	190	2,60	1,80	FastFix	16	W	47.190.16.FF	43,00 CHF	
NEU	190	2,80	1,80	30	2/7/42	32	W	47.190.30.32	57,00 CHF
NEU	190	2,60	1,80	FastFix	32	W	47.190.32.FF	57,00 CHF	
190	2,80	1,80	30	2/7/42	48	W	47.190.30.48	77,00 CHF	
NEU	190	2,40	1,80	FastFix	48	W	47.190.48.FF	77,00 CHF	
NEU	190	2,60	1,80	30	2/7/42	54	FT	21.190.30.54	87,00 CHF
NEU	190	2,60	1,80	FastFix	54	FT	21.190.54.FF	87,00 CHF	
NEU	190	2,60	2,00	FastFix	58	FT, neg.	42.190.58.FF	95,00 CHF	
NEU	190	2,80	2,20	30	2/7/42	68	FT, neg.	42.190.30.68	109,00 CHF
NEU	210	2,60	1,80	30	2/7/42	18	W	47.210.30.18	50,00 CHF
NEU	210	2,40	1,80	30	2/7/42	36	W	47.210.30.36	72,00 CHF
NEU	210	2,40	1,80	30	2/7/42	52	W	47.210.30.52	93,00 CHF
NEU	210	2,40	1,80	30	2/7/42	60	FT	47.210.30.60	99,00 CHF
NEU	210	2,40	1,80	30	2/7/42	72	FT, neg.	42.210.30.72	122,00 CHF
NEU	225	2,60	1,80	30	2/7/42	18	W	47.225.30.18	53,00 CHF
225	2,50	1,80	30	2/7/42	32	W	47.225.30.32	65,00 CHF	
225	2,50	1,80	30	2/7/42	48	W	47.225.30.48.B25	87,00 CHF	
NEU	225	2,60	1,80	30	2/7/42	64	FT	47.225.30.64	102,00 CHF
NEU	225	2,60	2,00	30	2/7/42 + 2/9/46,5 + 2/10/60	68	FT, neg.	42.225.30.68.B26	121,00 CHF
NEU	260	2,40	1,80	30	2/7/42 + 2/9/46,5 + 2/10/60	68	FT, neg.	42.260.30.68	140,00 CHF

## Diamant-Trennscheiben galvanisch

### Disques à tronçonner diamantés galvanisé



**Typ 1**  
Umfang  
Périphérie

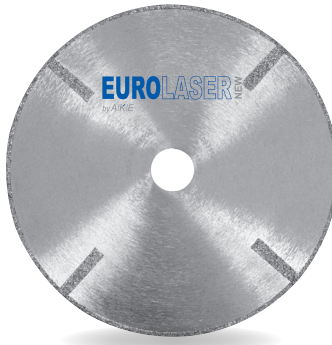

**Typ 2**  
Umfang und Seitenbelag  
Périphérie et latéral

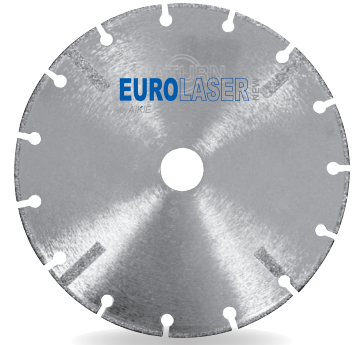

**Typ 3**  
Umfang, Seitenbelag und  
segmentiert  
Périphérie, latéral et lame  
à segment

#### ANWENDUNG

Trockenschnitt

#### WERKSTOFF

für abrasive Materialien, Zementfaserplatten Eternit, Marmor, glasfaserverstärkte Kunststoffe GFK, kohlefaserverstärkte Kunststoffe CFK, Kevlar

#### MASCHINE

Handkreissägen, Tisch-, Format und Kappkreissägen

#### UTILISATION

Sciage à sec sans arrosage

#### MATERIAU

Pour matériau abrasif, ciment, placoplatre, eternit, marbre, Epoxy, fibre de verre GFK, matériau à fort alliage, PVC, Kevlar

#### MACHINE

Scie à format, portable, scie radiale et pendulaire

Abmessungen Dimensions	Typ	Preis Prix
160 x 2,6 x 20 mm	1	146,00 CHF
160 x 2,6 x 20 mm	2	146,00 CHF
160 x 2,6 x 20 mm	3	160,00 CHF
190 x 2,8 x 30 mm	1	180,00 CHF
200 x 2,8 x 30 mm	3	210,00 CHF
215 x 2,8 x 30 mm	3	210,00 CHF
230 x 2,8 x 30 mm	3	262,00 CHF
250 x 2,8 x 30 mm	3	300,00 CHF
300 x 3,0 x 30 mm	3	390,00 CHF
350 x 3,0 x 30 mm	3	490,00 CHF
400 x 3,4 x 30 mm	3	560,00 CHF

# Kappkreissägeblatt

## Lames pour bois et profilés PVC



ANWENDUNG	Querschnitt
WERKSTOFF	Massivholz, Holzwerkstoff, Thermoplast, Duroplast-Profil
MASCHINE	Kappkreissäge
AUSFÜHRUNG	Negativer Spanwinkel
ZAHN	Wechselzahn (W) negativ, HW
UTILISATION	Coupe en long, tronçonnage
MATERIAU	Bois massif, profilés PVC à parois minces, Thermoplast, Duroplast
MACHINE	Scie à format, scie radiale, scie pendulaire
EXECUTION	Angle d'attaque négatif
DENTURE	Alternée (W) négative, HW

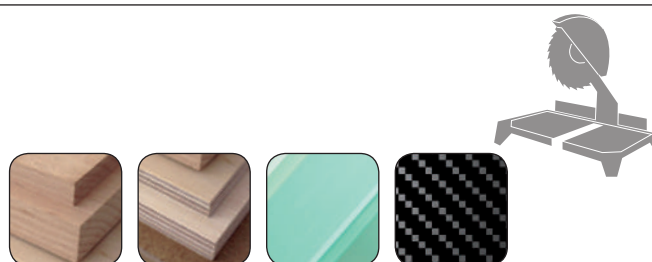
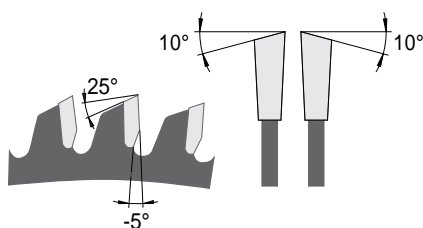

	D mm	B mm	b mm	d mm	NL/TK mm TE	Z	Zahnform Denture	Bestellnummer Références	Preis Prix
NEU	210	2,80	2,00	30		24	W, neg.	18.210.30.24	55,00 CHF
	210	2,80	2,00	30		40	W, neg.	18.210.30.40	71,00 CHF
	210	2,80	2,00	30		60	W, neg.	18.210.30.60	86,00 CHF
NEU	210	2,80	2,00	30		80	W, neg.	18.210.30.80	104,00 CHF
	216	2,80	2,00	30		24	W, neg.	18.216.30.24	57,00 CHF
	216	2,80	2,00	30		48	W, neg.	18.216.30.48	76,00 CHF
	216	2,80	2,00	30		60	W, neg.	18.216.30.60	89,00 CHF
	216	2,80	2,00	30		80	W, neg.	18.216.30.80	107,00 CHF
NEU	250	3,20	2,20	20	2/7/42 + 2/9/46,5 + 2/10/60	24	W, neg.	18.250.20.24	63,00 CHF
	250	3,20	2,20	30	2/7/42 + 2/9/46,5 + 2/10/60	24	W, neg.	18.250.30.24	63,00 CHF
	250	3,20	2,20	20	2/7/42 + 2/9/46,5 + 2/10/60	48	W, neg.	18.250.20.48	89,00 CHF
	250	3,20	2,20	30	2/7/42 + 2/9/46,5 + 2/10/60	48	W, neg.	18.250.30.48	89,00 CHF
	250	3,20	2,20	30	2/7/42 + 2/9/46,5 + 2/10/60	60	W, neg.	18.250.30.60	100,00 CHF
	250	3,20	2,20	30	2/7/42 + 2/9/46,5 + 2/10/60	80	W, neg.	18.250.30.80	123,00 CHF
	260	2,50	1,80	30	2/7/42 + 2/9/46,5 + 2/10/60	24	W, neg.	18.260.30.24	83,00 CHF
	260	2,50	1,80	30	2/7/42 + 2/9/46,5 + 2/10/60	48	W, neg.	18.260.30.48	106,00 CHF
	260	2,50	1,80	30	2/7/42 + 2/9/46,5 + 2/10/60	60	W, neg.	18.260.30.60	119,00 CHF
	260	2,50	1,80	30	2/7/42 + 2/9/46,5 + 2/10/60	80	W, neg.	18.260.30.80	125,00 CHF
	300	3,20	2,20	30	2/7/42 + 2/9/46,5 + 2/10/60	72	W, neg.	18.300.30.72	148,00 CHF
	300	3,20	2,20	30	2/7/42 + 2/9/46,5 + 2/10/60	96	W, neg.	18.300.30.96	165,00 CHF
NEU	305	2,60	1,80	30	2/7/42 + 2/9/46,5 + 2/10/60	32	W, neg.	18.305.30.32	103,00 CHF
	305	2,80	2,00	30	2/7/42 + 2/9/46,5 + 2/10/60	48	W, neg.	18.305.30.48	117,00 CHF
	305	2,80	2,00	30	2/7/42 + 2/9/46,5 + 2/10/60	60	W, neg.	18.305.30.60	131,00 CHF
NEU	305	2,80	2,00	30	2/7/42 + 2/9/46,5 + 2/10/60	72	W, neg.	18.305.30.72	156,00 CHF
NEU	305	2,80	2,00	30	2/7/42 + 2/9/46,5 + 2/10/60	96	W, neg.	18.305.30.96	173,00 CHF
	350	3,20	2,20	40	2/7/42 + 2/9/46,5 + 2/10/60	72	W, neg.	18.350.40.72	165,00 CHF

Alle Preise zuzüglich Mehrwertsteuer.



## Zuschnittkreissägeblatt

Lames pour machines stationnaires



ANWENDUNG	Universeller Einsatz auf Wipp- und Bausägen
WERKSTOFF	Massivholz, Heraklithplatte, Holzwerkstoff, Schalungsmaterial
MASCHINE	Wippsäge, Brennholzsäge, Baukreissäge
AUSFÜHRUNG	Zähes Hartmetall, stabiler Zahnrücken am Grundkörper, spandickenbegrenzt (SDB)
ZAHN	Wechselzahn (W), HW
UTILISATION	Lames universelles de chantier, coupe en long et en travers
MATERIAU	Bois massif, bois de chauffage, panneaux, hourdis légers
MACHINE	Electroportatives, scie à format, tronçonneuses
EXECUTION	Carbure spécifique pour bois massif et hourdis légers, avec et sans limiteurs de prises de passes (SDB)
DENTURE	Alternée (W), HW

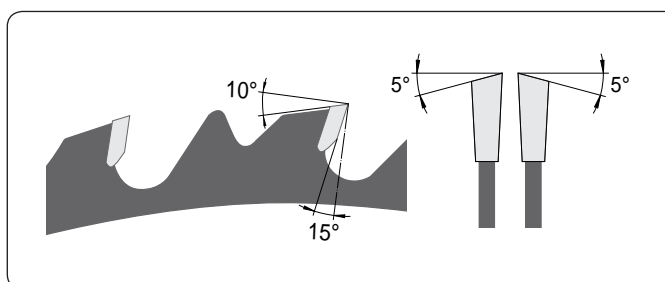

D mm	B mm	b mm	d mm	NL/TK mm TE	Z	Zahnform Denture	Bestellnummer Références	Preis Prix
300	3,40	2,20	30	2/7/42 + 2/9/46,5 + 2/10/60	24	W, SDB	49.300.30.24	76,00 CHF
315	3,40	2,20	30	2/7/42 + 2/9/46,5 + 2/10/60	24	W, SDB	49.315.30.24	81,00 CHF
350	3,50	2,50	30	2/7/42 + 2/9/46,5 + 2/10/60	24	W, SDB	49.350.30.24	85,00 CHF
400	3,50	2,50	30	2/7/42 + 2/9/46,5 + 2/10/60	28	W, SDB	49.400.30.28	100,00 CHF
400	3,50	2,50	30	2/7/42 + 2/9/46,5 + 2/10/60	36	W, SDB	49.400.30.36	111,00 CHF
450	4,00	2,80	30	2/7/42 + 2/9/46,5 + 2/10/60	32	W, SDB	49.450.30.32	126,00 CHF
500	4,00	2,80	30	2/7/42 + 2/9/46,5 + 2/10/60	36	W, SDB	49.500.30.36	149,00 CHF
550	4,00	2,80	30	2/7/42 + 2/9/46,5 + 2/10/60	48	W, SDB	49.550.30.48	200,00 CHF
NEU 600	4,00	2,80	30	2/10/60 + 2/12/72	40	W, SDB	49.600.30.40	196,00 CHF
600	4,00	2,80	30	2/10/60 + 2/12/72	54	W, SDB	49.600.30.54	234,00 CHF
650	4,40	3,20	30	2/10/60 + 2/12/72	54	W, SDB	49.650.30.54	292,00 CHF
700	4,40	3,20	30	2/10/60 + 2/12/72	46	W, SDB	49.700.30.46	287,00 CHF
700	4,40	3,20	30	2/10/60 + 2/12/72	60	W, SDB	49.700.30.60	315,00 CHF

## Baukreissägeblatt

Lames de chantier, pour bois massif



ANWENDUNG

WERKSTOFF

MASCHINE

AUSFÜHRUNG

ZAHN

UTILISATION

MATERIAU

MACHINE

EXECUTION

DENTURE

Für härteste Anforderungen im Baubereich

Holzwerkstoff mit Einschlüssen, Holzwoolplatte, Gasbeton, Gipskarton, Schalungsmaterial etc.

Baukreissäge, Wippsäge, Brennholzsäge

Zähes Hartmetall, stabiler Zahnrücken am Grundkörper

Trapezzahn (T), HW

Denture trapézoïdale moins fragile en cas de sciage accidentel de corps étrangers (clous ou agrafes)

Bois massif, hourdis légers, planches de coffrage, plaques de plâtre, etc.

Lames de chantier

Carbure spécifique pour bois massif

Trapézoïdale (T), HW

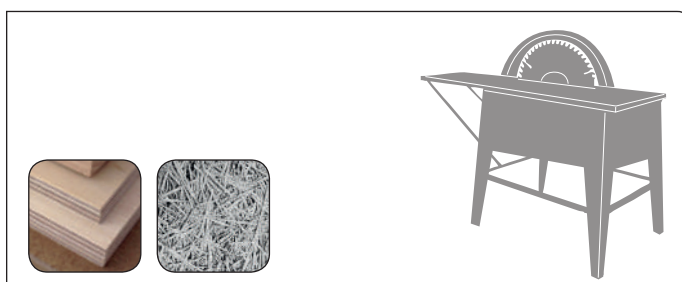
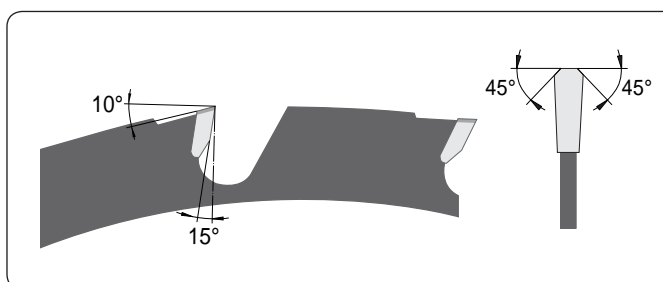

D mm	B mm	b mm	d mm	NL/TK mm TE	Z	Zahnform Denture	Bestellnummer Références	Preis Prix
300	3,40	2,20	30	2/7/42 + 2/9/46,5 + 2/10/60	20	T	50.300.30.20	70,00 CHF
315	3,40	2,20	30	2/7/42 + 2/9/46,5 + 2/10/60	20	T	50.315.30.20	76,00 CHF
350	3,60	2,50	30	2/7/42 + 2/9/46,5 + 2/10/60	12	T	50.350.30.12	68,00 CHF
350	3,60	2,50	30	2/7/42 + 2/9/46,5 + 2/10/60	24	T	50.350.30.24	82,00 CHF
400	3,60	2,50	30	2/7/42 + 2/9/46,5 + 2/10/60	28	T	50.400.30.28	96,00 CHF
450	4,00	2,80	30	2/7/42 + 2/9/46,5 + 2/10/60	14	T	50.450.30.14	108,00 CHF
450	3,80	2,50	30	2/7/42 + 2/9/46,5 + 2/10/60	32	T	50.450.30.32	123,00 CHF
500	4,40	2,80	30	2/7/42 + 2/9/46,5 + 2/10/60	36	T	50.500.30.36	159,00 CHF
NEU 600	4,40	2,80	30	2/10/60 + 2/12/72	40	T	50.600.30.40	196,00 CHF
NEU 700	4,40	3,20	30	2/10/60 + 2/12/72	46	T	50.700.30.46	287,00 CHF

# Aluminiumkreissägeblatt

Lames pour ALU et PVC



ANWENDUNG	Bearbeitung von Aluminium in Profil, Platte, Stange
WERKSTOFF	Aluminium, Kupferlegierung (z.B. Messing), Kunststoff
MASCHINE	Tisch- und Formatkreissäge
AUSFÜHRUNG	Positiver Spanwinkel
ZAHN	Flach-Trapezzahn (FT) positiv, HW
UTILISATION	Denture trapézoïdale moins fragile en cas de sciage accidentel de corps étrangers (clous ou agrafes)
MATERIAU	Bois massif, hourdis légers, planches de coffrage, plaques de plâtre, etc.
MACHINE	Lames de chantier
EXECUTION	Carbure spécifique pour bois massif
DENTURE	Trapézoïdale (T), HW

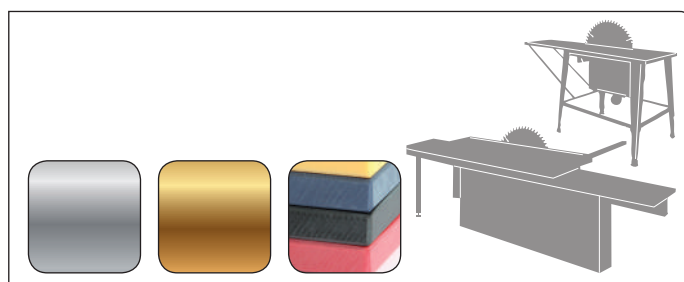
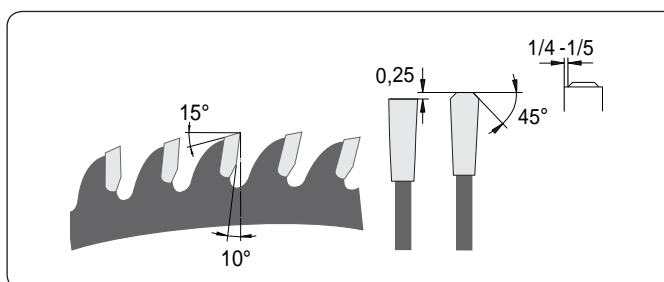

D mm	B mm	b mm	d mm	NL/TK mm TE	Z	Zahnform Denture	Bestellnummer Références	Preis Prix
200	2,80	2,20	20	2/6/32	54	FT	40.200.20.54	101,00 CHF
200	2,80	2,20	20	2/6/32	72	FT	40.200.20.72	112,00 CHF
250	3,20	2,50	30	2/7/42 + 2/9/46,5 + 2/10/60	66	FT	40.250.30.66	118,00 CHF
250	3,20	2,50	30	2/7/42 + 2/9/46,5 + 2/10/60	80	FT	40.250.30.80	143,00 CHF
275	3,20	2,50	40	2/9/55 + 4/12/64	72	FT	40.275.40.72	146,00 CHF
300	3,20	2,50	30	2/7/42 + 2/9/46,5 + 2/10/60	72	FT	40.300.30.72	150,00 CHF
300	3,20	2,50	30	2/7/42 + 2/9/46,5 + 2/10/60	84	FT	40.300.30.84	155,00 CHF
300	3,20	2,50	30	2/7/42 + 2/9/46,5 + 2/10/60	96	FT	40.300.30.96	161,00 CHF
320	3,20	2,50	30	2/7/42 + 2/9/46,5 + 2/10/60	84	FT	40.320.30.84	163,00 CHF
330	3,20	2,50	32	2/7/42 + 2/9/46,5 + 2/10/60	84	FT	40.330.32.84	167,00 CHF
330	3,20	2,50	32	2/7/42 + 2/9/46,5 + 2/10/60	96	FT	40.330.32.96	195,00 CHF
350	3,40	2,80	30	2/7/42 + 2/9/46,5 + 2/10/60	84	FT	40.350.30.84	177,00 CHF
350	3,40	2,80	30	2/7/42 + 2/9/46,5 + 2/10/60	90	FT	40.350.30.90	195,00 CHF
350	3,20	2,50	30	2/7/42 + 2/9/46,5 + 2/10/60	108	FT	40.350.30.108	208,00 CHF

# Aluminiumkreissägeblatt

Lames pour ALU et PVC



ANWENDUNG	Bearbeitung von NE-Metallen und Kunststoff sowie für universellen Einsatz mit unterschiedlichen Werkstoffen
WERKSTOFF	Aluminium, Holzwerkstoff beschichtet, Kunststoff, Thermofassadenelement, Verbundwerkstoff
MASCHINE	Handkreissäge, Tisch- und Formatkreissäge, Kappkreissäge
AUSFÜHRUNG	Negativer Spanwinkel
ZAHN	Flach-Trapezzahn (FT) negativ, HW
UTILISATION	Coupe de profilés ALU, PVC, coupe sur chantier de panneaux composites de façade (nous consulter), métaux non ferreux
MACHINE	Tronçonneuses, scies à onglet, scie à format, scies radiales, scies pendulaires, scies électroportatives, CNC
EXECUTION	Angle d'attaque négatif
DENTURE	Plate-Trapézoïdale (PT) négative, HW

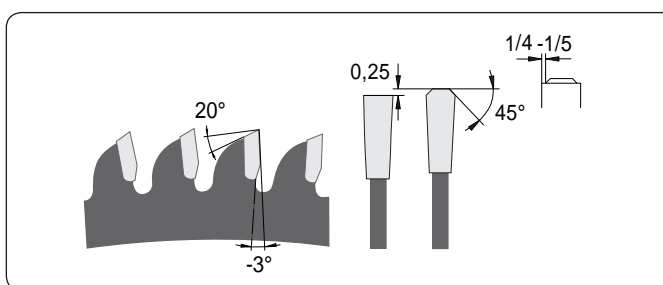

D mm	B mm	b mm	d mm	NL/TK mm TE	Maschine Machine	Z	Zahnform Denture	Bestellnummer Références	Preis Prix
150	2,80	2,00	20	2/6/32		42	FT, neg.	42.150.20.42	74,00 CHF
160	2,80	2,00	20	2/6/32		42	FT, neg.	42.160.20.42	77,00 CHF
NEU 160	2,20	1,60	20	2/6/32	Festool	52	FT, neg.	42.160.20.52	85,00 CHF
NEU 160	2,80	2,00	20	2/6/32		56	FT, neg.	42.160.20.56	104,00 CHF
180	2,80	2,00	20	2/6/32		48	FT, neg.	42.180.20.48	87,00 CHF
180	2,80	2,00	30	2/7/42		48	FT, neg.	42.180.30.48	87,00 CHF
190	2,80	2,00	20	2/6/32		54	FT, neg.	42.190.20.54	88,00 CHF
190	2,80	2,00	30	2/7/42		54	FT, neg.	42.190.30.54	88,00 CHF
NEU 190	2,60	2,00	FastFix		Festool	58	FT, neg.	42.190.58.FF	95,00 CHF
NEU 190	2,80	2,20	30	2/7/42	Festool	68	FT, neg.	42.190.30.68	109,00 CHF
200	2,80	2,00	30	2/7/42		54	FT, neg.	42.200.30.54	93,00 CHF
210	2,80	2,00	30	2/7/42		54	FT, neg.	42.210.30.54	95,00 CHF
NEU 210	2,40	1,80	30	2/7/42	Festool	72	FT, neg.	42.210.30.72	122,00 CHF
216	2,80	2,00	30	2/7/42		48	FT, neg.	42.216.30.48	93,00 CHF
216	2,80	2,00	30	2/7/42		60	FT, neg.	42.216.30.60	114,00 CHF
NEU 216	2,80	2,00	30	2/7/42		80	FT, neg.	42.216.30.80	126,00 CHF
220	2,80	2,00	30	2/7/42 + 2/9/46,5 + 2/10/60		54	FT, neg.	42.220.30.54	98,00 CHF
225	2,80	2,00	30	2/7/42 + 2/9/46,5 + 2/10/60		60	FT, neg.	42.225.30.60	110,00 CHF
NEU 225	2,50	1,80	30	2/7/42 + 2/9/46,5 + 2/10/60	Mafell	68	FT, neg.	42.225.30.68.B25	121,00 CHF
NEU 225	2,60	2,00	30	2/7/42 + 2/9/46,5 + 2/10/60	Festool	68	FT, neg.	42.225.30.68.B26	121,00 CHF
NEU 230	2,80	2,00	30	2/7/42 + 2/9/46,5 + 2/10/60		64	FT, neg.	42.230.30.64	112,00 CHF

# Aluminiumkreissägeblatt

Lames pour ALU et PVC

D mm	B mm	b mm	d mm	NL/TK mm TE	Maschine Machine	Z	Zahnform Denture	Bestellnummer Références	Preis Prix
235	2,80	2,00	30	2/7/42 + 2/9/46,5 + 2/10/60		64	FT, neg.	42.235.30.64	114,00 CHF
240	2,80	2,00	30	2/7/42 + 2/9/46,5 + 2/10/60		64	FT, neg.	42.240.30.64	115,00 CHF
250	3,20	2,50	30	2/7/42 + 2/9/46,5 + 2/10/60		54	FT, neg.	42.250.30.54	126,00 CHF
250	2,80	2,20	30	2/7/42 + 2/9/46,5 + 2/10/60		80	FT, neg.	42.250.30.80.B28	132,00 CHF
250	3,20	2,50	30	2/7/42 + 2/9/46,5 + 2/10/60		80	FT, neg.	42.250.30.80.B32	136,00 CHF
260	2,50	1,80	30	2/7/42 + 2/9/46,5 + 2/10/60		64	FT, neg.	42.260.30.64.B25	133,00 CHF
260	3,20	2,50	30	2/7/42 + 2/9/46,5 + 2/10/60		64	FT, neg.	42.260.30.64.B32	136,00 CHF
NEU	260	2,40	30	2/7/42 + 2/9/46,5 + 2/10/60	Festool	68	FT, neg.	42.260.30.68	140,00 CHF
260	3,20	2,50	30	2/7/42 + 2/9/46,5 + 2/10/60		80	FT, neg.	42.260.30.80	148,00 CHF
275	3,20	2,50	40	2/9/55 + 4/12/64		88	FT, neg.	42.275.40.88	168,00 CHF
NEU	280	3,20	30	2/7/42 + 2/9/46,5 + 2/10/60		80	FT, neg.	42.280.30.80	164,00 CHF
300	3,20	2,50	30	2/7/42 + 2/9/46,5 + 2/10/60		72	FT, neg.	42.300.30.72	154,00 CHF
300	3,20	2,50	30	2/7/42 + 2/9/46,5 + 2/10/60		96	FT, neg.	42.300.30.96	161,00 CHF
305	2,80	2,20	30	2/7/42 + 2/9/46,5 + 2/10/60		80	FT, neg.	42.305.30.80.B28	165,00 CHF
305	3,20	2,50	30	2/7/42 + 2/9/46,5 + 2/10/60		80	FT, neg.	42.305.30.80.B32	168,00 CHF
330	3,20	2,50	30	2/7/42 + 2/9/46,5 + 2/10/60		84	FT, neg.	42.330.30.84	184,00 CHF
330	3,20	2,50	30	2/7/42 + 2/9/46,5 + 2/10/60		102	FT, neg.	42.330.30.102	219,00 CHF
350	3,20	2,50	30	2/7/42 + 2/9/46,5 + 2/10/60		84	FT, neg.	42.350.30.84	161,00 CHF
350	3,20	2,50	30	2/7/42 + 2/9/46,5 + 2/10/60		108	FT, neg.	42.350.30.108	205,00 CHF

## Sandwichkreissägeblatt

### Lames pour panneaux sandwich



ANWENDUNG	Bearbeitung von Sandwichmaterialien
WERKSTOFF	Sandwichelement, blechbewehrt ohne Steinwolle
MASCHINE	Baukreissäge, Handkreissäge, Kappkreissäge
AUSFÜHRUNG	Mit Sonderhartmetall, Negativer Spanwinkel
ZAHN	Flach-Trapezzahn (FT) negativ, HW
UTILISATION	Lames pour panneaux sandwich
MATERIAU	Panneaux sandwich, tôles acier doux, planches de coffrage
MACHINE	Tronçonneuses de chantier, électroportatives, scies radiales
EXECUTION	Carbure spécifique, angle d'attaque négatif
DENTURE	Plate-Trapézoïdale (PT) négative, HW

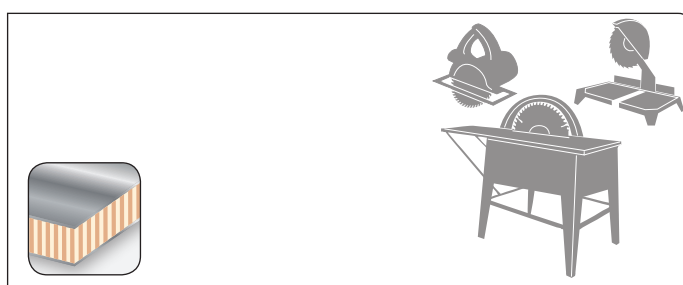
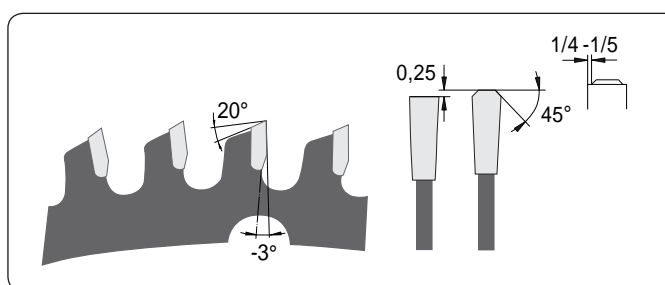

	D mm	B mm	b mm	d mm	NL/TK mm TE	n max	Z	Zahnform Denture	Bestellnummer Références	Preis Prix
NEU	160	2,00	1,60	20	2/6/32	2.800	42	FT, neg.	54.160.20.42	80,00 CHF
	190	2,00	1,60	20	2/6/32	2.400	54	FT, neg.	54.190.20.54	90,00 CHF
	190	2,00	1,60	30	2/6/32	2.400	54	FT, neg.	54.190.30.54	90,00 CHF
NEU	230	2,00	1,60	30	2/7/42	2.000	60	FT, neg.	54.230.30.60	111,00 CHF
	250	2,00	1,60	30	2/7/42 + 2/9/46,5 + 2/10/60	1.800	80	FT, neg.	54.250.30.80	135,00 CHF
	280	2,20	1,80	30	2/7/42 + 2/9/46,5 + 2/10/60	1.500	84	FT, neg.	54.280.30.84	163,00 CHF
	300	2,20	1,80	30	2/7/42 + 2/9/46,5 + 2/10/60	1.500	96	FT, neg.	54.300.30.96	182,00 CHF
	355	2,20	1,80	30	2/7/42 + 2/9/46,5 + 2/10/60	1.450	96	FT, neg.	54.355.30.96	195,00 CHF

## Dry-Cut-Kreissägeblatt

### Lames Dry-Cut



ANWENDUNG	Kappschnitt in unterschiedlichstem Material
WERKSTOFF	Baustahl, Kupfer, Profilblech, Aluminium, Kabelkanal usw.
MASCHINE	Dry-Cutter für Trockenschnitte ohne Schmierung
AUSFÜHRUNG	Dünne Schnittbreite, niedrige Schnittgeschwindigkeit
ZAHN	Wechselzahn mit Flachfase (W/Fa), HW
UTILISATION	Tronçonnage de différents matériaux
MATERIAU	Acier doux, tôles ondulées, cuivre, laiton, etc.
MACHINE	Dry-Cutter - coupe à sec, sans lubrification
EXECUTION	Trait de scie mince, attention vitesse de coupe 25 m/sec maxi
DENTURE	Alternée avec chanfrein de sécurité (W/Fa), HW

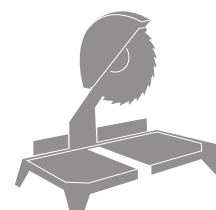
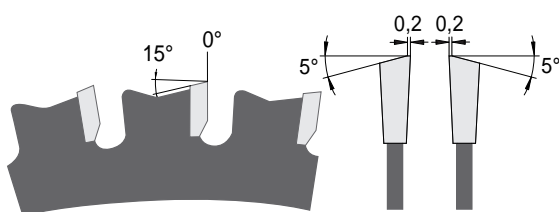

	D mm	B mm	b mm	d mm	NL/TK mm TE	n max	Z	Zahnform Denture	Bestellnummer Références	Preis Prix
NEU	136	1,50	1,20	20		3.000	30	W/Fa	56.136.20.30	58,00 CHF
NEU	150	2,00	1,60	20	2/6/32	3.000	30	W/Fa	56.150.20.30	59,00 CHF
	160	2,00	1,60	20	2/6/32	2.800	30	W/Fa	56.160.20.30	60,00 CHF
NEU	165	1,50	1,20	20		2.600	30	W/Fa	56.165.20.30	61,00 CHF
NEU	180	2,00	1,60	30	2/7/42	2.500	34	W/Fa	56.180.30.34	66,00 CHF
	190	2,00	1,60	30	2/7/42	2.400	38	W/Fa	56.190.30.38	71,00 CHF
	190	2,00	1,60	30	2/7/42	2.400	48	W/Fa	56.190.30.48	98,00 CHF
NEU	200	2,00	1,60	30	2/7/42	2.200	40	W/Fa	56.200.30.40	79,00 CHF
	210	2,00	1,60	30	2/7/42	2.100	40	W/Fa	56.210.30.40	80,00 CHF
	216	2,00	1,60	30	2/7/42	2.100	40	W/Fa	56.216.30.40	84,00 CHF
	216	2,00	1,60	30	2/7/42	2.100	54	W/Fa	56.216.30.54	104,00 CHF
NEU	230	2,00	1,60	25,4		2.000	44	W/Fa	56.230.25.44	89,00 CHF
	230	2,00	1,60	30	2/7/42 + 2/9/46,5 + 2/10/60	2.000	44	W/Fa	56.230.30.44	89,00 CHF
NEU	235	2,00	1,60	30	2/7/42	1.800	44	W/Fa	56.235.30.44	93,00 CHF
NEU	240	2,20	1,80	30	2/7/42 + 2/9/46,5 + 2/10/60	1.800	44	W/Fa	56.240.30.44	98,00 CHF
	250	2,20	1,80	30	2/7/42 + 2/9/46,5 + 2/10/60	1.800	48	W/Fa	56.250.30.48	109,00 CHF
NEU	250	2,20	1,80	30	2/7/42 + 2/9/46,5 + 2/10/60	1.800	60	W/Fa	56.250.30.60	123,00 CHF
NEU	255	2,20	1,80	25,4		1.500	48	W/Fa	56.255.25.48	116,00 CHF
	255	2,20	1,80	25,4		1.500	60	W/Fa	56.255.25.60	130,00 CHF
	305	2,20	1,80	25,4		1.500	60	W/Fa	56.305.25.60	144,00 CHF
	305	2,20	1,80	30	2/7/42 + 2/9/46,5 + 2/10/60	1.500	60	W/Fa	56.305.30.60	144,00 CHF
	305	2,20	1,80	25,4		1.500	80	W/Fa	56.305.25.80	168,00 CHF
	305	2,20	1,80	30	2/7/42 + 2/9/46,5 + 2/10/60	1.500	80	W/Fa	56.305.30.80	168,00 CHF
	350	2,40	2,00	30	2/7/42 + 2/9/46,5 + 2/10/60	1.500	80	W/Fa	56.350.30.80	195,00 CHF
NEU	355	2,40	2,00	25,4		1.500	72	W/Fa	56.355.25.72	181,00 CHF
	355	2,40	2,00	25,4		1.500	90	W/Fa	56.355.25.90	210,00 CHF
	400	3,00	2,50	30	2/7/42 + 2/9/46,5 + 2/10/60	1.500	84	W/Fa	56.400.30.84	223,00 CHF

## Diamant-Kreissägeblatt (DP)

### Lames de scie Diamant (DP)



WERKSTOFF	Holzwerkstoff, Zementfaserplatten Eternit, Fermacel, Duripanel, Vollkernplatten, glasfaserverstärkte Kunststoffe GFK, CFK, Kevlar
MASCHINE	Handkreissäge, Kappkreissäge, Tisch- und Formatkreissäge
AUSFÜHRUNG	Spandickenbegrenzt (SDB)
ZAHN	Flachzahn (F) negativ, DP
MATERIAU	Panneaux en matériau composite, plaques de fibro-ciment Eternit, Plaques de plâtre, epoxy, fibre de verre GFK, CFK, Kevlar
MACHINE	Electroportatives, scies à format
EXECUTION	Avec limiteurs de prise de passes (SDB)
DENTURE	DP Plate (P) négative

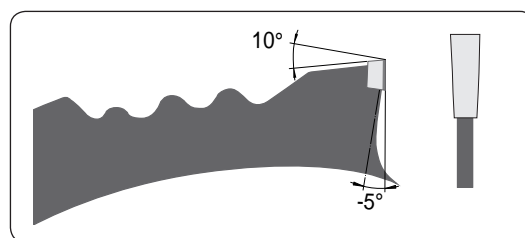

**ANWENDUNG** **Niedrige Zähnezahl:**  
Längsschnitt und Querschnitt in schwer zerspanbaren und werkzeugverschleißenden Materialien, wie Zementgebundene Faserplatten, Gipsplatten und Laminat. Für groben Zuschnitt und geringere Staubentwicklung.

**UTILISATION** **Nombre de dents bas:**  
Pour coupe de finition moyenne dans matériaux très abrasifs avec une tenue de coupe élevée. Ne convient pas pour métaux ferreux, verre et pierre.

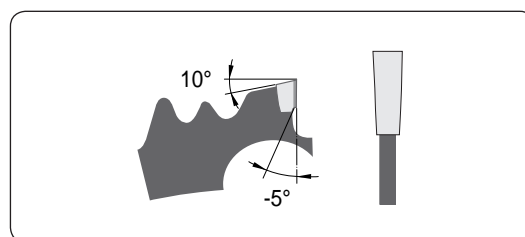

**ANWENDUNG** **Höhere Zähnezahl:**  
Ebenfalls für Längsschnitt und Querschnitt in schwer zerspanbaren und werkzeugverschleißenden Materialien (s. oben). Zusätzlich lässt sich ein deutlich besseres Schnittergebnis erzielen. Diese Werkzeuge sind somit auch verstärkt für den Einsatz in Holz- und Holzwerkstoffen geeignet.

**UTILISATION** **Nombre de dents haut:**  
Pour coupe de finition haute dans matériaux très abrasifs avec une tenue de coupe élevée. Ne convient pas pour métaux ferreux, verre et pierre.



## Diamant-Kreissägeblatt (DP)

Lames de scie Diamant (DP)



	D mm	B mm	b mm	d mm	NL/TK mm TE	Z	Zahnform Denture	Bestellnummer Références	Preis Prix
	160	2,40	1,60	20/30		4	F, SDB, neg.	18.160.20.04	125,00 CHF
	160	2,40	1,60	20/30		8	F, SDB, neg.	18.160.20.08	180,00 CHF
NEU	160	2,40	1,60	20/30		12	F, SDB, neg.	18.160.20.12	267,00 CHF
NEU	160	2,40	1,60	20/30		16	F, SDB, neg.	18.160.20.16	341,00 CHF
NEU	160	2,40	1,60	20/30		24	F, SDB, neg.	18.160.20.24	449,00 CHF
	185	2,40	1,60	15,87	1/4/39,87	4	F, SDB, neg.	18.185.15.04	125,00 CHF
	185	2,40	1,60	15,87	1/4/39,87	8	F, SDB, neg.	18.185.15.08	180,00 CHF
	190	2,40	1,60	20/20		4	F, SDB, neg.	18.190.20.04	125,00 CHF
	190	2,40	1,60	20/30		8	F, SDB, neg.	18.190.20.08	180,00 CHF
NEU	190	2,40	1,60	20/30		12	F, SDB, neg.	18.190.20.12	267,00 CHF
NEU	190	2,40	1,60	20/30		16	F, SDB, neg.	18.190.20.16	341,00 CHF
NEU	190	2,40	1,60	20/30		24	F, SDB, neg.	18.190.20.24	449,00 CHF
	200	2,40	1,60	30		4	F, SDB, neg.	18.200.30.04	125,00 CHF
	200	2,40	1,60	30		8	F, SDB, neg.	18.200.30.08	180,00 CHF
	216	2,40	1,60	30		8	F, SDB, neg.	18.216.30.08	180,00 CHF
	216	2,40	1,60	30		12	F, SDB, neg.	18.216.30.12	267,00 CHF
NEU	216	2,40	1,60	30		16	F, SDB, neg.	18.216.30.16	341,00 CHF
NEU	216	2,40	1,60	30		24	F, SDB, neg.	18.216.30.24	449,00 CHF
	230	2,40	1,60	20/30		6	F, SDB, neg.	18.230.20.06	154,00 CHF
	230	2,40	1,60	20/30		12	F, SDB, neg.	18.230.20.12	267,00 CHF
	250	2,40	1,60	30	2/7/42 + 2/9/46,5 + 2/10/60	6	F, SDB, neg.	18.250.30.06	154,00 CHF
	250	2,40	1,60	30	2/7/42 + 2/9/46,5 + 2/10/60	12	F, SDB, neg.	18.250.30.12	267,00 CHF
NEU	250	2,40	1,60	30	2/7/42 + 2/9/46,5 + 2/10/60	16	F, SDB, neg.	18.250.30.16	341,00 CHF
NEU	250	2,40	1,60	30	2/7/42 + 2/9/46,5 + 2/10/60	24	F, SDB, neg.	18.250.30.24	449,00 CHF
NEU	250	2,40	1,60	30	2/7/42 + 2/9/46,5 + 2/10/60	32	F, SDB, neg.	18.250.30.32	567,00 CHF
NEU	260	2,40	1,60	30	2/7/42 + 2/9/46,5 + 2/10/60	6	F, SDB, neg.	18.260.30.06	170,00 CHF
NEU	260	2,40	1,60	30	2/7/42 + 2/9/46,5 + 2/10/60	12	F, SDB, neg.	18.260.30.12	294,00 CHF
NEU	260	2,40	1,60	30	2/7/42 + 2/9/46,5 + 2/10/60	16	F, SDB, neg.	18.260.30.16	375,00 CHF
NEU	260	2,40	1,60	30	2/7/42 + 2/9/46,5 + 2/10/60	24	F, SDB, neg.	18.260.30.24	494,00 CHF
	300	2,40	1,60	30	2/7/42 + 2/9/46,5 + 2/10/60	12	F, SDB, neg.	18.300.30.12	294,00 CHF
	300	2,40	1,60	30	2/7/42 + 2/9/46,5 + 2/10/60	20	F, SDB, neg.	18.300.30.20	435,00 CHF
NEU	300	2,40	1,60	30	2/7/42 + 2/9/46,5 + 2/10/60	28	F, SDB, neg.	18.300.30.28	532,00 CHF
NEU	300	2,40	1,60	30	2/7/42 + 2/9/46,5 + 2/10/60	36	F, SDB, neg.	18.300.30.36	658,00 CHF

Die mit Bohrung „20/30“ gekennzeichneten Werkzeuge werden in Bohrung 20mm gefertigt. Als kostenlosen Service bieten wir Ihnen eine Bohrungsänderung auf 30mm an. Wünschen Sie eine Bohrung 30mm, so genügt ein Vermerk auf Ihrer Bestellung.

## CV-Kreissägeblatt, KV-A Wolfszahn

Scie circulaire chrome-vanadium dent-de-loup



ANWENDUNG	Längsschnitt, Querschnitt
WERKSTOFF	Massivholz weich bis hart, Holzwerkstoff
MASCHINE	Wippsäge, Brennholzsäge, Baukreissäge, Tischkreissäge
ZAHN	KV-A Wolfszahn, Chrom-Vanadium (CV)
UTILISATION	Coupe en long et en travers
MATERIAU	Bois massif tendre, dur, bois
MACHINE	Scie pour bois à bruler, lames de chantier, scie à format
DENTURE	KV-A dent-de-loup

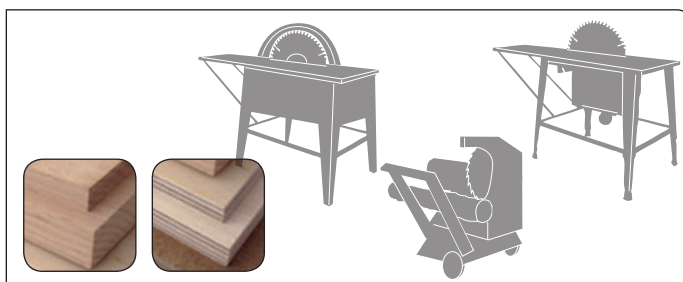
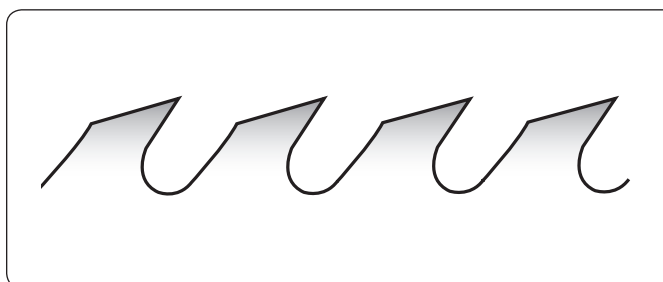

D mm	B mm	d mm	Z	Zahnform Denture	Bestellnummer Références	Preis Prix
250	1,60	30	48	KV-A	51.250.30.48	47,00 CHF
300	1,60	30	56	KV-A	51.300.30.56	51,00 CHF
315	1,80	30	56	KV-A	51.315.30.56	55,00 CHF
350	1,80	30	56	KV-A	51.350.30.56	62,00 CHF
400	2,00	30	56	KV-A	51.400.30.56	81,00 CHF
450	2,50	30	56	KV-A	51.450.30.56	113,00 CHF
500	2,50	30	56	KV-A	51.500.30.56	132,00 CHF
550	2,60	30	56	KV-A	51.550.30.56	187,00 CHF
600	2,80	30	56	KV-A	51.600.30.56	190,00 CHF
650	3,00	30	56	KV-A	51.650.30.56	233,00 CHF
700	3,20	30	56	KV-A	51.700.30.56	237,00 CHF

## CV-Kreissägeblatt, NV-B Spitzzahn

### Scie circulaire chrome-vanadium dent pointu



ANWENDUNG	Längsschnitt, Querschnitt
WERKSTOFF	Massivholz weich bis hart, Holzwerkstoff
MASCHINE	Baukreissäge, Wippsäge, Brennholzsäge, Tischkreissäge
ZAHN	NV-B Spitzzahn, Chrom-Vanadium (CV)
UTILISATION	Coupe en long et en travers
MATERIAU	Bois massif tendre, dur, bois
MACHINE	Scie pour bois à bruler, lames de chantier, scie à format
DENTURE	NV-B dent pointu

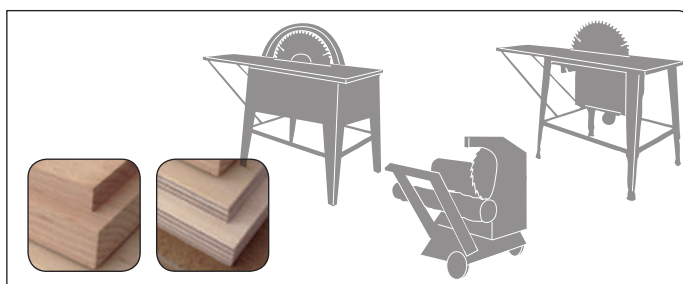
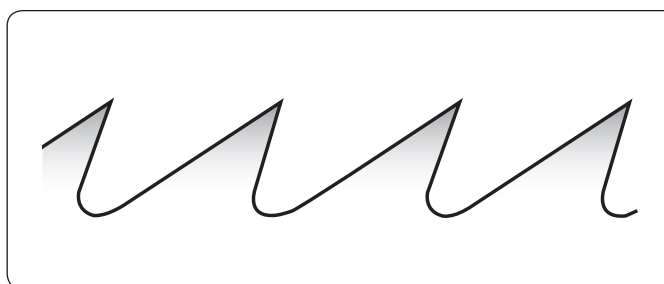

D mm	B mm	d mm	Z	Zahnform Denture	Bestellnummer Références	Preis Prix
300	1,60	30	80	NV-B	52.300.30.80	51,00 CHF
350	1,80	30	80	NV-B	52.350.30.80	62,00 CHF
400	2,00	30	80	NV-B	52.400.30.80	81,00 CHF
450	2,50	30	80	NV-B	52.450.30.80	113,00 CHF
500	2,50	30	80	NV-B	52.500.30.80	132,00 CHF
550	2,60	30	80	NV-B	52.550.30.80	187,00 CHF
600	2,80	30	80	NV-B	52.600.30.80	190,00 CHF
700	3,20	30	80	NV-B	52.700.30.80	237,00 CHF

# Vollstahl Kreissägeblatt, Trennschnitt in Metall

Fraises scie HSS pour l'acier

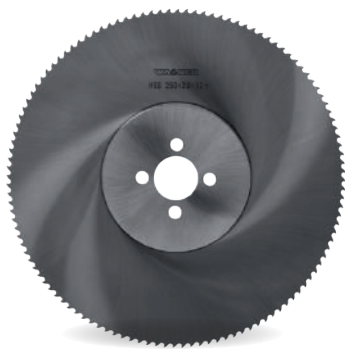

ANWENDUNG	Trennschnitt in Profil und Vollmaterial aus Metall
WERKSTOFF	Stahl und NE-Metall, Profil, Rohr, Vollmaterial
MASCHINE	Metallkreissäge
AUSFÜHRUNG	Qualität DM05
ZAHN	Form HZ und Form BW, beidseitig hohlgeschliffen, HS
UTILISATION	Tronçonneuses à métaux profilés ou massifs
MATERIAU	Acier, métaux non-ferreux, profilés et massifs
MACHINE	Tronçonneuses à métaux
EXECUTION	Qualité DM 05
DENTURE	Forme HZ et forme BW, angle radial sur les deux flancs, HS

Zahnform: BW

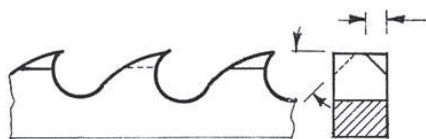

Zahnform: HZ

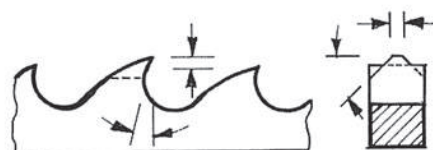

D mm	B mm	d mm	NL mm TE	Zahn-Teilung	Z	Bestellnummer Références	Preis Prix
225	2,00	32	2/8/45 + 2/9/50 + 2/11/63	6	120HZ	0836225120	78,00 CHF
225	2,00	40	2/8/55 + 4/12/64	6	120HZ	0836225121	78,00 CHF
225	2,00	32	2/8/45 + 2/9/50 + 2/11/63	4	180BW	0836225180	78,00 CHF
225	2,00	40	2/8/55 + 2/12/64	4	180BW	0836225181	78,00 CHF
225	2,00	32	2/8/45 + 2/9/50 + 2/11/63	3	220BW	0836225220	78,00 CHF
225	2,00	40	2/8/55 + 4/12/64	3	220BW	0836225221	78,00 CHF
250	2,00	32	2/8/45 + 2/9/50 + 2/11/63	8	100HZ	0836250100	81,00 CHF
250	2,00	40	2/8/55 + 4/12/64	8	100HZ	0836250101	81,00 CHF
250	2,00	32	2/8/45 + 2/9/50 + 2/11/63	6	128HZ	0836250128	81,00 CHF
250	2,00	40	2/8/55 + 4/12/64	6	128HZ	0836250129	81,00 CHF
250	2,00	40	2/8/55 + 4/12/64	4	200BW	0836250201	81,00 CHF
250	2,00	32	2/8/45 + 2/9/50 + 2/11/63	4	200BW	0836250200	81,00 CHF
275	2,50	32	2/8/45 + 2/9/50 + 2/11/63	8	110HZ	0836275112	97,00 CHF
275	2,50	40	2/8/55 + 4/12/64	8	110HZ	0836275113	97,00 CHF
275	2,50	32	2/8/45 + 2/9/50 + 2/11/63	6	140HZ	0836275142	97,00 CHF
275	2,50	40	2/8/55 + 4/12/64	6	140HZ	0836275143	97,00 CHF
275	2,50	32	2/8/45 + 2/9/50 + 2/11/63	5	180HZ	0836275182	97,00 CHF
275	2,50	40	2/8/55 + 4/12/64	5	180HZ	0836275183	97,00 CHF
275	2,50	32	2/8/45 + 2/9/50 + 2/11/63	4	220BW	0836275220	97,00 CHF
275	2,50	40	2/8/55 + 4/12/64	4	220BW	0836275223	97,00 CHF
275	2,50	32	2/8/45 + 2/9/50 + 2/11/63	3	280BW	0836275292	97,00 CHF
275	2,50	40	2/8/55 + 4/12/64	3	280BW	0836275283	97,00 CHF

## Vollstahl Kreissägeblatt, Trennschnitt in Metall

Fraises scie HSS pour l'acier

D mm	B mm	d mm	NL mm TE	Zahn-Teilung	Z	Bestellnummer Références	Preis Prix
300	2,50	32	2/8/45 + 2/9/50 + 2/11/63	8	120HZ	0836300122	133,00 CHF
300	2,50	40	2/8/55 + 4/12/64	8	120HZ	0836300123	133,00 CHF
300	2,50	32	2/8/45 + 2/9/50 + 2/11/63	6	160HZ	0836300162	133,00 CHF
300	2,50	40	2/8/55 + 4/12/64	6	160HZ	0836300163	133,00 CHF
300	2,50	32	2/8/45 + 2/9/50 + 2/11/63	4	220BW	0836300222	133,00 CHF
300	2,50	40	2/8/55 + 4/12/64	4	220BW	0836300223	133,00 CHF
315	2,50	32	2/8/45 + 2/9/50 + 2/11/63	8	120HZ	0836315120	149,00 CHF
315	3,00	40	2/8/55 + 4/12/64	8	120HZ	0836315123	174,00 CHF
315	2,50	32	2/8/45 + 2/9/50 + 2/11/63	6	160HZ	0836315160	149,00 CHF
315	3,00	40	2/8/55 + 4/12/64	6	160HZ	0836315163	174,00 CHF
315	2,50	32	2/8/45 + 2/9/50 + 2/11/63	4	240BW	0836315240	149,00 CHF
315	3,00	40	2/8/55 + 4/12/64	4	240BW	0836315243	174,00 CHF
350	3,00	40	2/8/55 + 4/12/64	10	110HZ	0836350114	196,00 CHF
350	3,00	50	4/15/80 + 4/14/85	9	120HZ	0836350125	196,00 CHF
350	2,50	32	2/8/45 + 2/9/50 + 2/11/63	8	140HZ	0836350140	185,00 CHF
350	3,00	40	2/8/55 + 4/12/64	8	140HZ	0836350144	196,00 CHF
350	3,00	50	4/15/80 + 4/14/85	7	160HZ	0836350165	196,00 CHF
350	3,00	40	2/8/55 + 4/12/64	6	180HZ	0836350184	196,00 CHF
350	3,00	50	4/15/80 + 4/14/85	5	220HZ	0836350225	196,00 CHF
370	3,00	50	4/15/80 + 4/14/85	9	120HZ	0836370122	260,00 CHF
370	3,00	50	4/15/80 + 4/14/85	7	160HZ	0836370162	260,00 CHF
370	3,00	50	4/15/80 + 4/14/85	5	220HZ	0836370222	260,00 CHF
400	3,50	40	2/8/55 + 4/12/64	12	96HZ	0836400102	315,00 CHF
400	3,50	40	2/8/55 + 4/12/64	10	120HZ	0836400122	315,00 CHF
400	3,50	40	2/8/55 + 4/12/64	8	160HZ	0836400162	315,00 CHF
400	3,50	40	2/8/55 + 4/12/64	6	200HZ	0836400202	315,00 CHF

Weitere Ausführungen mit abweichenden Spezifikationen sind auf Anfrage lieferbar,  
z.B. für eloxiertes oder lackiertes Aluminium.

## Reduzierringe für Kreissägeblätter

### Bagues de réduction pour lames circulaires

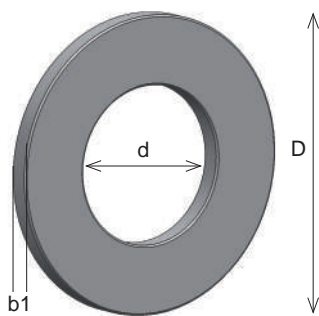

Zum Reduzieren der Bohrung bei Sägeblättern. Den Reduzierring breit genug wählen, um ein Verschieben des Ringes in die Flanschaussparung zu verhindern. Das Sägeblatt muss bei Verwendung eines Reduzierendes immer noch genügend vom Flansch gespannt werden.

Choisir une épaisseur suffisante afin d'assurer le centrage de la lame en toutes circonstances, notamment en cas de glissement de la bague vers le creux des flasques

D mm	B mm	d mm	Bestellnummer Références
16	1,60	12,7	059101607
16	1,60	13	059101613
20	1,60	12,7	059102007
20	1,60	15,875	059102087
20	1,60	16	059102016
20	1,60	18	059102018
25	2,00	15,875	059102587
25	2,00	16	059102516
25	2,00	20	059102520
25	2,00	22,225	059102522
30	2,00	15	059103015
30	2,20	15	059203015
30	2,00	15,875	059103087
30	2,20	15,875	059203087
30	2,00	16	059103016
30	2,20	16	059203016
30	2,00	18	059103018
30	2,20	18	059203018
30	2,00	20	059103020
30	2,20	20	059203020
30	2,00	22	059103022
30	2,40	22	059203022
30	2,00	25	059103025
30	2,20	25	059203025
30	2,00	25,4	059103054
30	2,20	25,4	059203054
30	2,80	25,4	059303054
32	2,00	20	059103220
32	2,20	20	059203220
32	2,00	25	059103225
32	2,20	25	059203225
32	2,00	30	059103230
32	2,20	30	059203230
40	1,60	30	059104030
40	2,00	30	059204030
40	1,60	32	059104032
40	2,00	32	059204032
40	1,60	35	059104035
40	2,00	35	059204035



Perfect. Economic. **EUROLASER**<sup>NEW</sup>

**EUROLASER**<sup>NEW</sup>  
by A|K|E

**Katalog 2015 | 2016**

Die EUROLASER NEW-  
Werkzeugpalette bietet ein  
attraktives Kompletprogramm  
mit über 450 Kreissägeblättern.

Sie werden nach bewährten  
A|K|E-Standards gefertigt und  
sind speziell für den Einsatz  
beim Handwerker sowie  
anspruchsvollen  
Heimwerker ausgelegt.

